

# SKM 195GB063DN

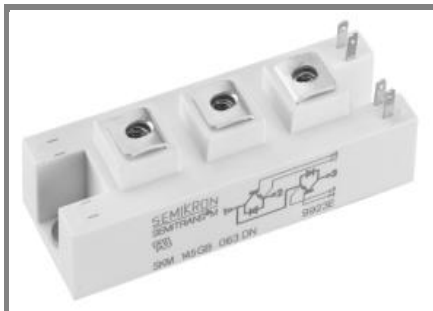

**SEMITRANS™ 2N**

## Superfast NPT-IGBT Modules

**SKM 195GB063DN**

**SKM 195GAL063DN**

**SKM 195GAR063DN**

### Features

- N channel, homogeneous Silicon structure (NPT - Non Punch-through IGBT)
- Low tail current with low temperature dependence
- High short circuit capability, self limiting
- Pos. temp.-coeff. of  $V_{CEsat}$
- Low inductance case
- Fast & soft inverse CAL diodes
- Without hard mould
- Large clearance (10 mm) and creepage distances (20 mm)

### Typical Applications

- Switching (not for linear use)
- Switched mode power supplies
- AC inverter drives
- UPS uninterruptable power supplies

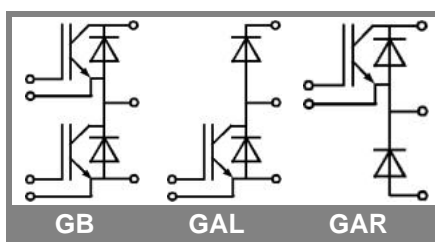

Absolute Maximum Ratings		$T_c = 25\text{ °C}$ , unless otherwise specified	
Symbol	Conditions	Values	Units
<b>IGBT</b>			
$V_{CES}$		600	V
$I_C$	$T_c = 25\text{ (85) °C}$	250 (190)	A
$I_{CRM}$	$t_p = 1\text{ ms}$	400	A
$V_{GES}$		$\pm 20$	V
$T_{vj}$ ( $T_{stg}$ )	$T_{OPERATION} \leq T_{stg}$	- 40 ... + 150 (125)	°C
$V_{isol}$	AC, 1 min.	2500	V
<b>Inverse diode</b>			
$I_F$	$T_c = 25\text{ (80) °C}$	200 (140)	A
$I_{FRM}$	$t_p = 1\text{ ms}$	400	A
$I_{FSM}$	$t_p = 10\text{ ms}$ ; sin.; $T_j = 150\text{ °C}$	1400	A

Characteristics		$T_c = 25\text{ °C}$ , unless otherwise specified			
Symbol	Conditions	min.	typ.	max.	Units
<b>IGBT</b>					
$V_{GE(th)}$	$V_{GE} = V_{CE}$ ; $I_C = 4\text{ mA}$	4,5	5,5	6,5	V
$I_{CES}$	$V_{GE} = 0$ ; $V_{CE} = V_{CES}$ ; $T_j = 25\text{ (125) °C}$		0,2	0,6	mA
$V_{CE(TO)}$	$T_j = 25\text{ (125) °C}$		1,05 (1)		V
$r_{CE}$	$V_{GE} = 15\text{ V}$ ; $T_j = 25\text{ (125) °C}$		5,25 (7)		mΩ
$V_{CE(sat)}$	$I_C = 200\text{ A}$ ; $V_{GE} = 15\text{ V}$ ; chip level		2,1 (2,4)	2,5 (2,8)	V
$C_{ies}$	under following conditions		11,2		nF
$C_{oes}$	$V_{GE} = 0$ ; $V_{CE} = 25\text{ V}$ ; $f = 1\text{ MHz}$		1,25		nF
$C_{res}$			0,75		nF
$L_{CE}$				25	nH
$R_{CC'+EE'}$	res.; terminal-chip $T_c = 25\text{ (125) °C}$		0,75 (1)		mΩ
$t_{d(on)}$	$V_{CC} = 300\text{ V}$ ; $I_C = 200\text{ A}$		120		ns
$t_r$	$R_{Gon} = R_{Goff} = 8\text{ Ω}$ ; $T_j = 125\text{ °C}$		85		ns
$t_{d(off)}$	$V_{GE} = \pm 15\text{ V}$		460		ns
$t_f$			50		ns
$E_{on} (E_{off})$			11,5 (7,5)		mJ
<b>Inverse diode</b>					
$V_F = V_{EC}$	$I_F = 150\text{ A}$ ; $V_{GE} = 0\text{ V}$ ; $T_j = 25\text{ (125) °C}$		1,45 (1,35)	1,7	V
$V_{(TO)}$	$T_j = 25\text{ (125) °C}$			0,9	V
$r_T$	$T_j = 25\text{ (125) °C}$		4	5,5	mΩ
$I_{RRM}$	$I_F = 200\text{ A}$ ; $T_j = 125\text{ ( ) °C}$		75		A
$Q_{rr}$	$di/dt = A/\mu s$		13		μC
$E_{rr}$	$V_{GE} = V$				mJ
<b>Thermal characteristics</b>					
$R_{th(j-c)}$	per IGBT			0,13	K/W
$R_{th(j-c)D}$	per Inverse Diode			0,3	K/W
$R_{th(c-s)}$	per module			0,05	K/W
<b>Mechanical data</b>					
$M_s$	to heatsink M6	3		5	Nm
$M_t$	to terminals M5	2,5		5	Nm
w				160	g

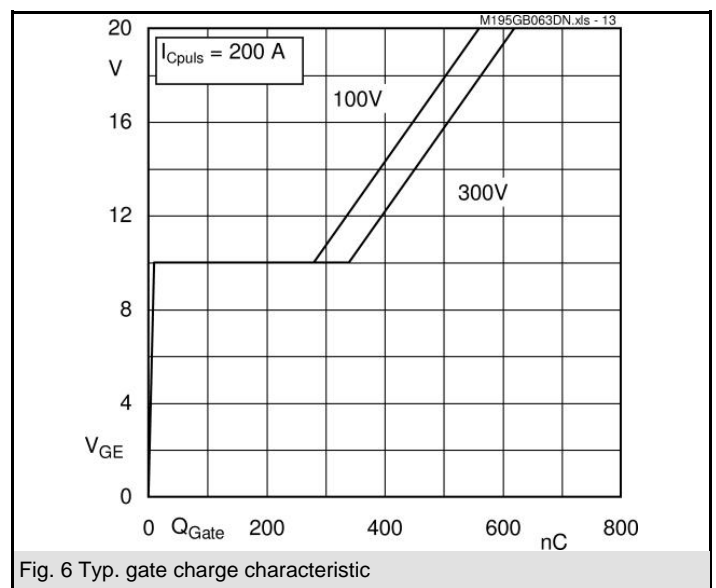
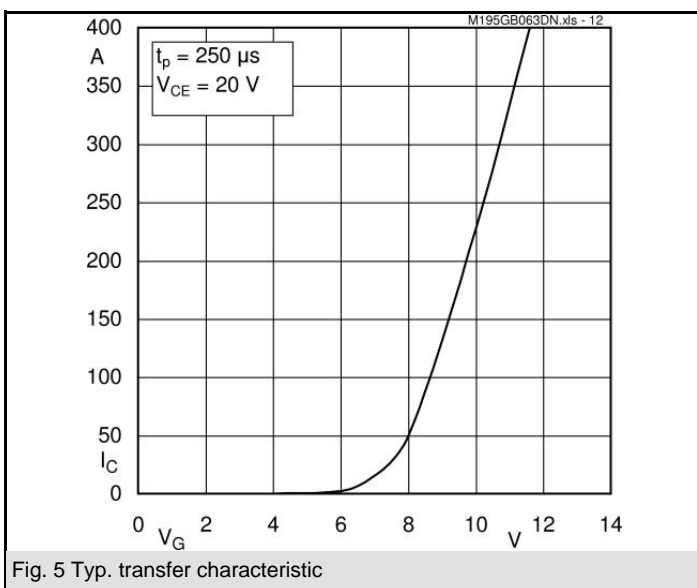
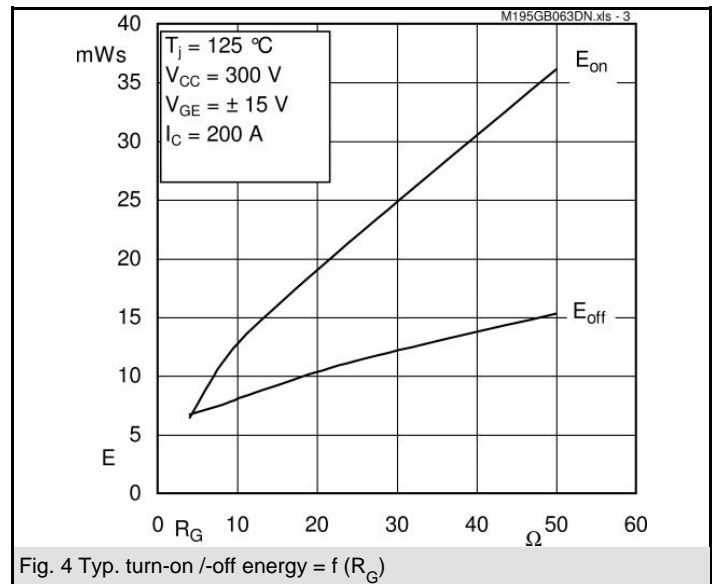
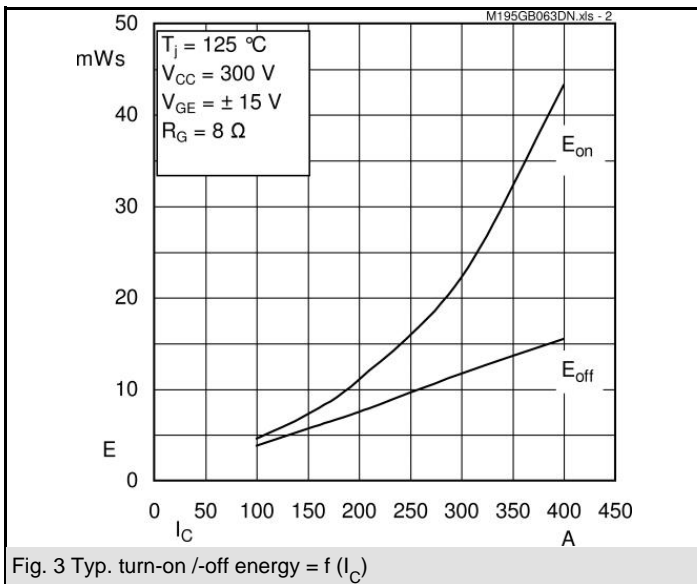
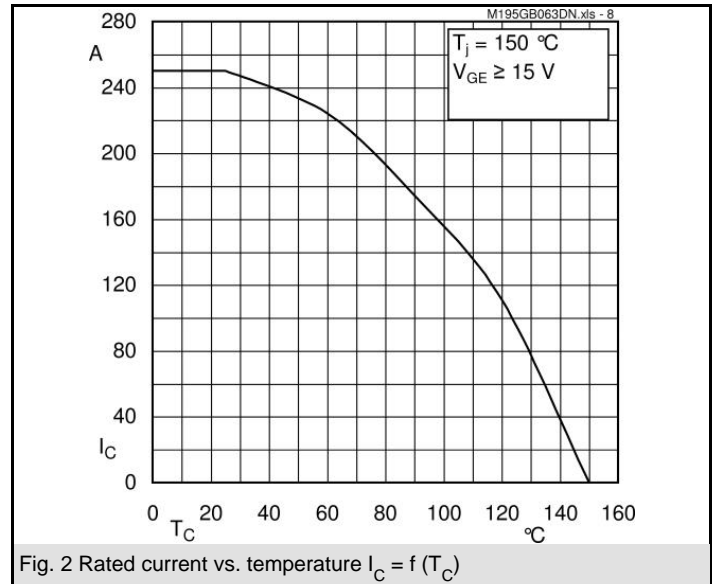
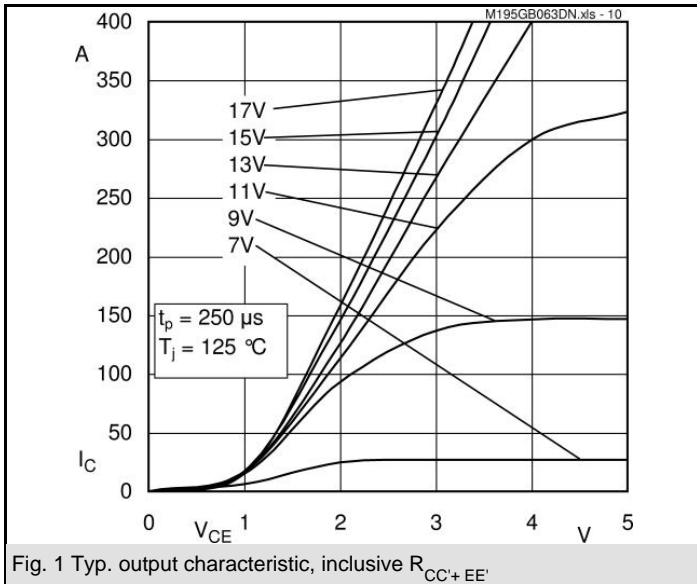

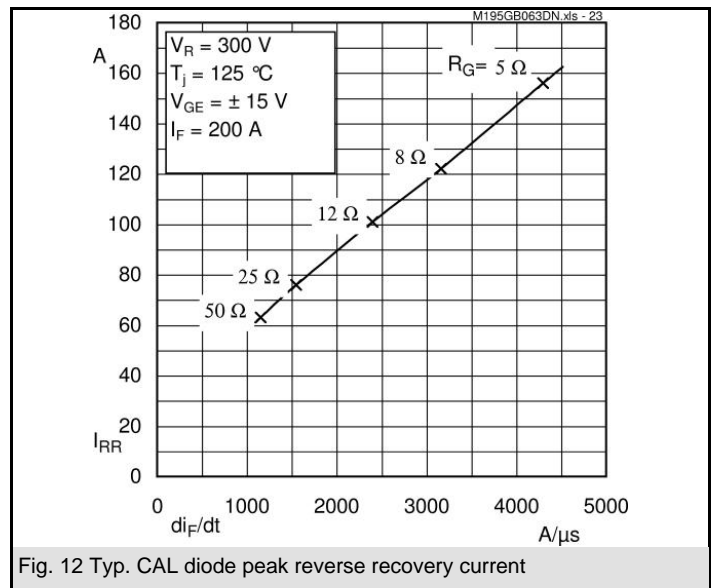
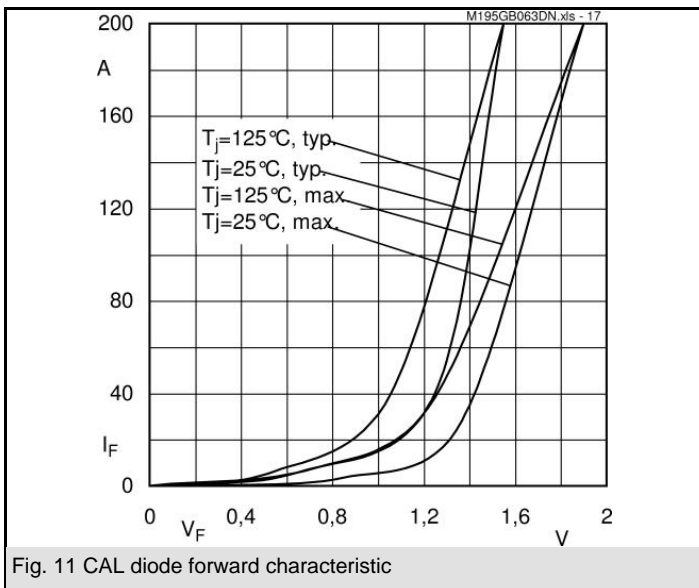
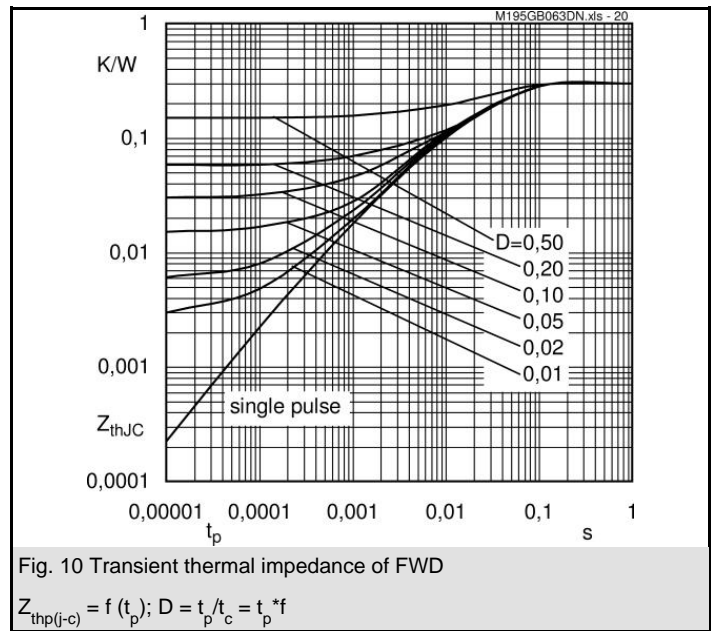
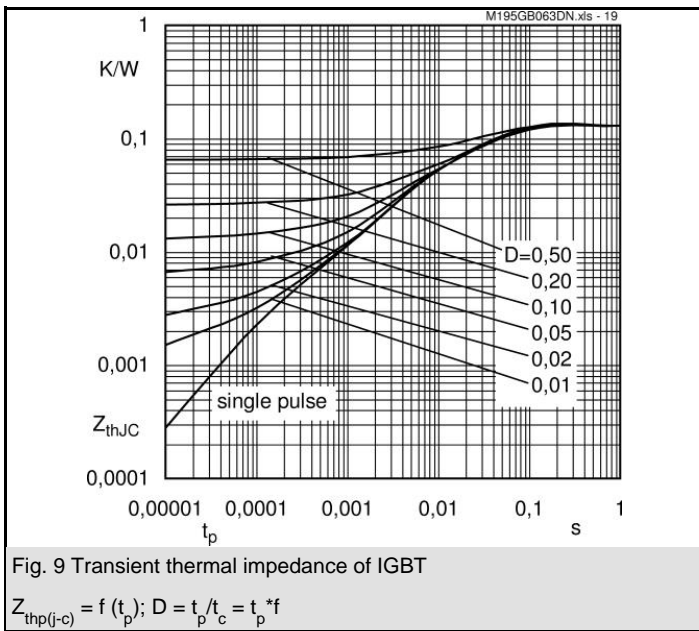
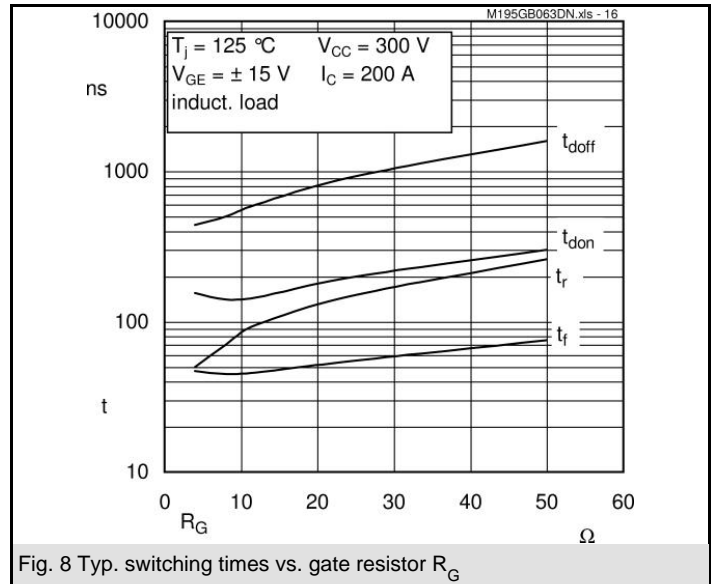
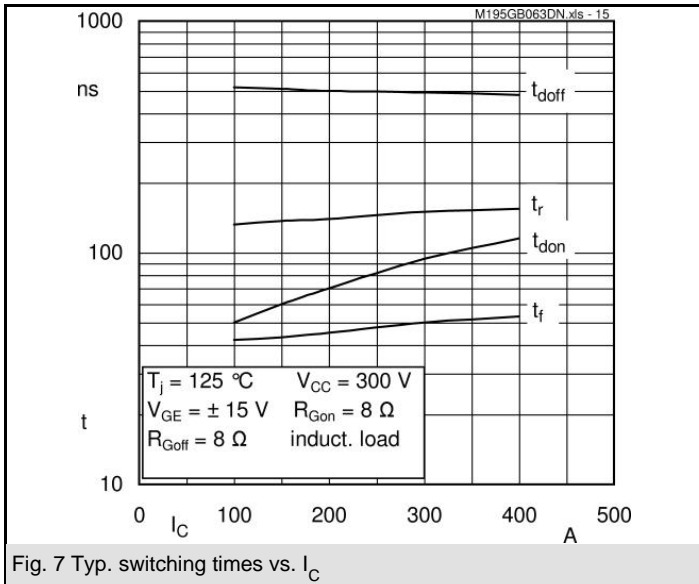

# SKM 195GB063DN

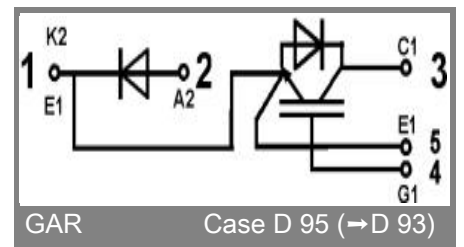
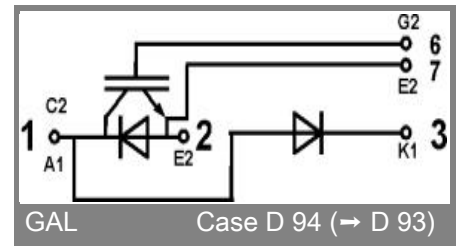
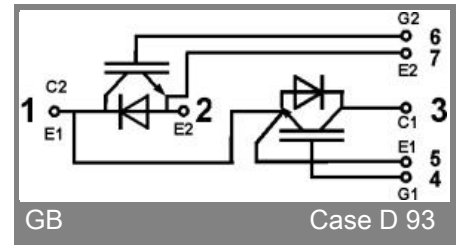
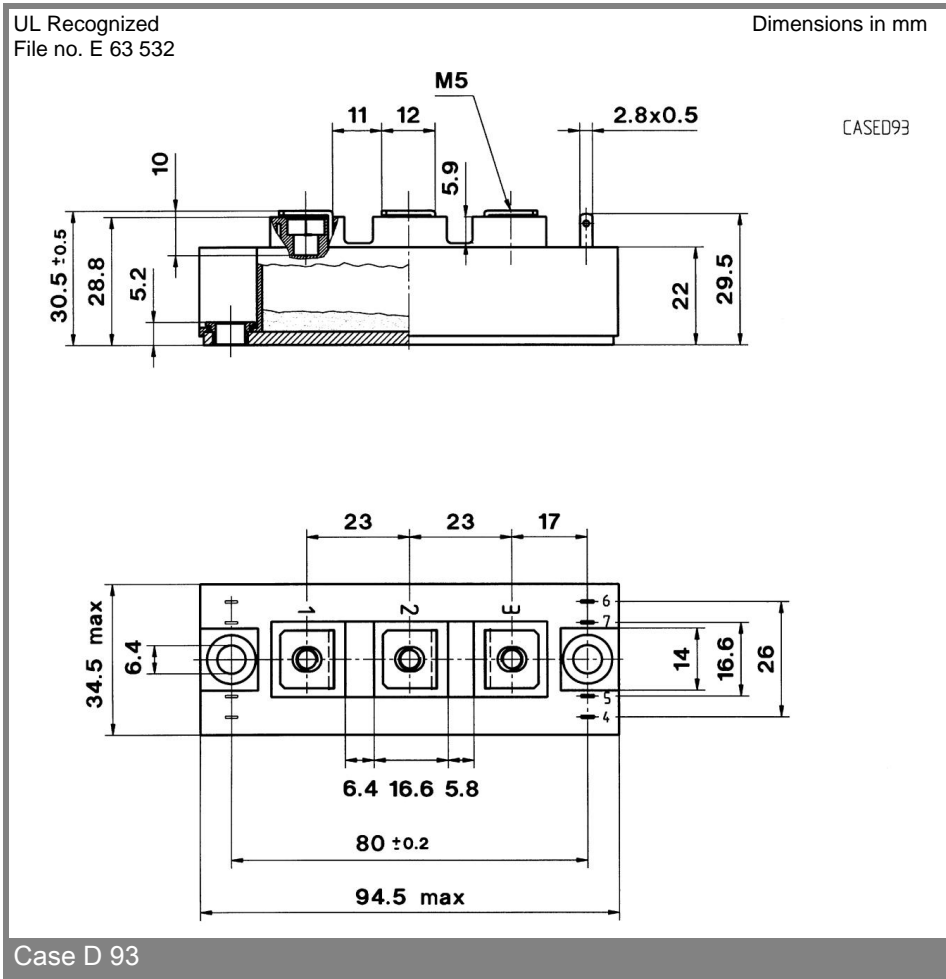
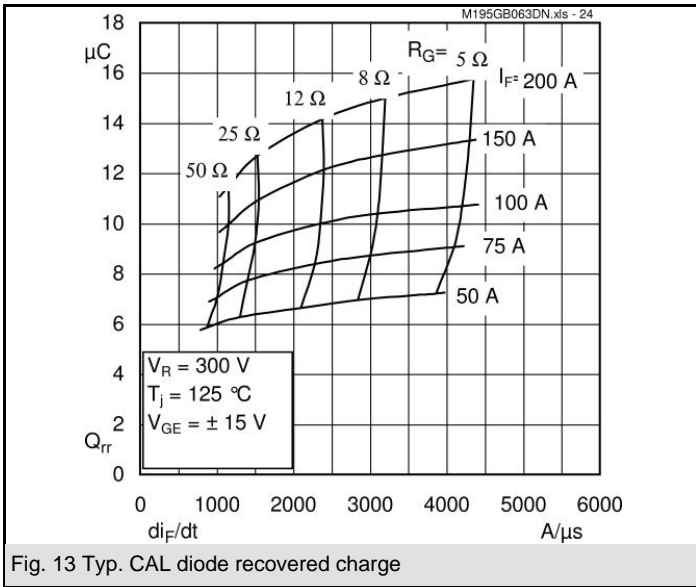

This is an electrostatic discharge sensitive device (ESDS), international standard IEC 60747-1, Chapter IX.

This technical information specifies semiconductor devices but promises no characteristics. No warranty or guarantee expressed or implied is made regarding delivery, performance or suitability.