

### Dual IGBT NFH-Series Module 200 Amperes/600 Volts

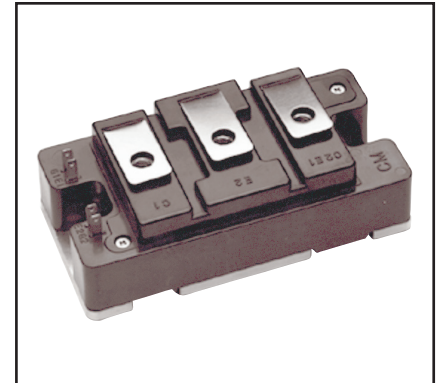
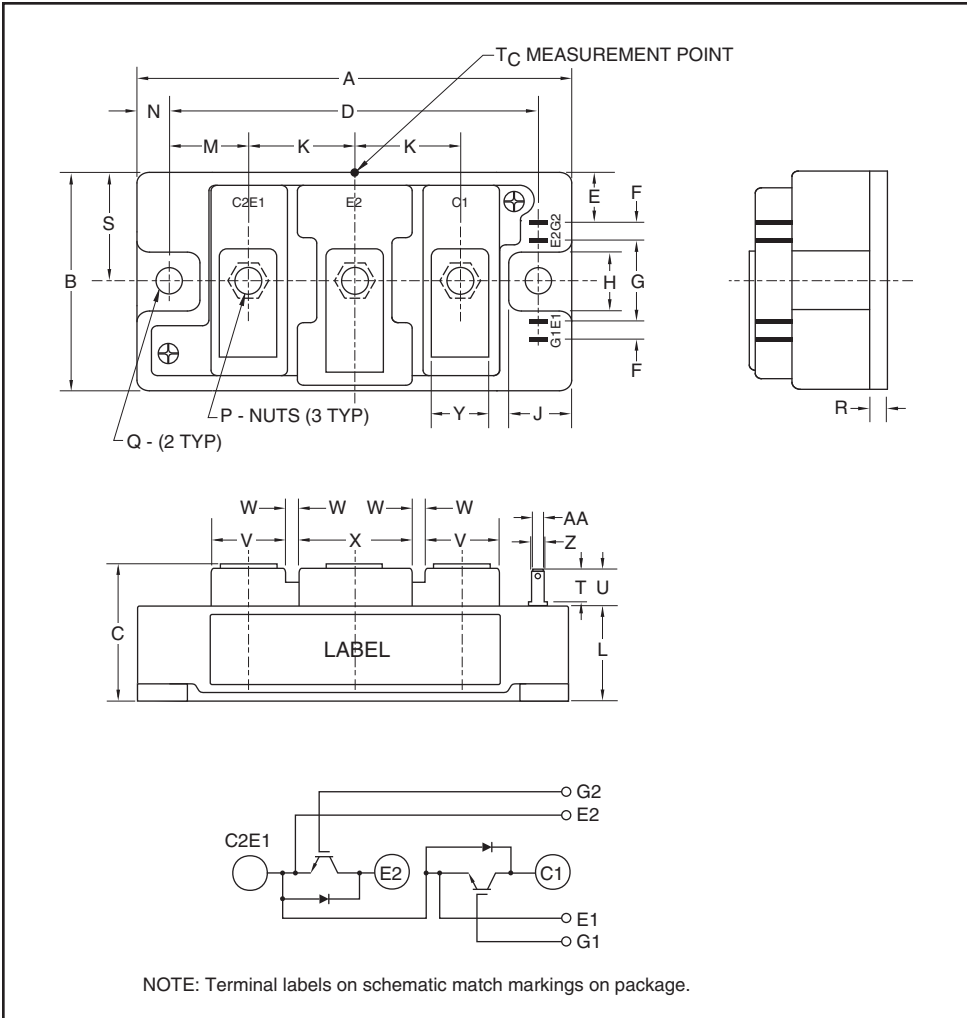

#### Description:

Powerex IGBT Modules are designed for use in high frequency applications; 30 kHz for hard switching applications and 60 to 70 kHz for soft switching applications. Each module consists of two IGBT Transistors Connected Common Emitter with each transistor having a reverse-connected super-fast recovery free-wheel diode. All components and interconnects are isolated from the heat sinking baseplate, offering simplified system assembly and thermal management.

#### Features:

- Low  $V_{CE(sat)}$
- Low  $E_{SW(off)}$
- Discrete Super-Fast Recovery Free-Wheel Diode
- Isolated Baseplate for Easy Heat Sinking

#### Applications:

- Power Supplies
- Induction Heating
- Welders

#### Ordering Information:

Example: Select the complete part module number you desire from the table below -i.e. CM200CU-12NFH is a 600V ( $V_{CES}$ ), 200 Ampere Dual IGBT Power Module.

#### Outline Drawing and Circuit Diagram

Dimensions	Inches	Millimeters
A	3.70	94.0
B	1.89	48.0
C	1.18+0.04/-0.01	30.0+1.0/-0.5
D	3.15±0.01	80.0±0.25
E	0.43	11.0
F	0.16	4.0
G	0.71	18.0
H	0.51	13.0
J	0.53	13.5
K	0.91	23.0
L	0.83	21.2
M	0.67	17.0
N	0.28	7.0

Dimensions	Inches	Millimeters
P	M5 Metric	M5
Q	0.26 Dia.	6.5 Dia.
R	0.02	4.0
S	0.94	24.0
T	0.3	7.5
U	0.33	8.5
V	0.63	16.0
W	0.1	2.5
X	0.98	25.0
Y	0.47	12.0
Z	0.16	4.0
AA	0.11	2.8

Type	Current Rating Amperes	$V_{CES}$ Volts (x 50)
CM	200	12



Powerex, Inc., 173 Pavilion Lane, Youngwood, Pennsylvania 15697 (724) 925-7272 [www.pwr.com](http://www.pwr.com)

**CM200CU-12NFH**  
**Dual IGBT NFH-Series Module**  
200 Amperes/600 Volts

**Absolute Maximum Ratings,  $T_j = 25^\circ\text{C}$  unless otherwise specified**

Ratings	Symbol	CM200CU-12NFH	Units
Junction Temperature	$T_j$	-40 to +150	$^\circ\text{C}$
Storage Temperature	$T_{\text{stg}}$	-40 to +125	$^\circ\text{C}$
Collector-Emitter Voltage (G-E Short)	$V_{\text{CES}}$	600	Volts
Gate-Emitter Voltage (C-E Short)	$V_{\text{GES}}$	$\pm 20$	Volts
Collector Current ( $T_C = 25^\circ\text{C}$ )	$I_C$	$200^{*2}$	Amperes
Peak Collector Current	$I_{\text{CM}}$	$400^{*2}$	Amperes
Emitter Current ( $T_C = 25^\circ\text{C}$ )* <sup>1</sup>	$I_E$	$200^{*2}$	Amperes
Peak Emitter Current* <sup>1</sup>	$I_{\text{EM}}$	$400^{*2}$	Amperes
Maximum Collector Dissipation ( $T_C = 25^\circ\text{C}$ , $T_j \leq ^\circ\text{C}$ )	$P_C$	590	Watts
Maximum Collector Dissipation ( $T_C = 25^\circ\text{C}$ , $T_j \leq ^\circ\text{C}$ )	$P_{C'}$	830	Watts
Mounting Torque, M5 Main Terminal	—	30	in-lb
Mounting Torque, M6 Mounting	—	40	in-lb
Weight	—	310	Grams
Isolation Voltage (Main Terminal to Baseplate, AC 1 Minute)	$V_{\text{ISO}}$	2500	Volts

\*<sup>1</sup> Represent ratings and characteristics of the anti-parallel, emitter-to-collector free wheeling diode (FWDi).

\*<sup>2</sup> Pulse width and repetition rate should be such that device junction temperature ( $T_j$ ) does not exceed  $T_{j(\text{max})}$  rating.

**CM200CU-12NFH**  
**Dual IGBT NFH-Series Module**  
 200 Amperes/600 Volts

**Electrical Characteristics,  $T_j = 25^\circ\text{C}$  unless otherwise specified**

Characteristics	Symbol	Test Conditions	Min.	Typ.	Max.	Units
Collector-Cutoff Current	$I_{CES}$	$V_{CE} = V_{CES}, V_{GE} = 0V$	—	—	1.0	mA
Gate Leakage Current	$I_{GES}$	$V_{GE} = V_{GES}, V_{CE} = 0V$	—	—	0.5	$\mu\text{A}$
Gate-Emitter Threshold Voltage	$V_{GE(th)}$	$I_C = 20\text{mA}, V_{CE} = 10V$	5.0	6.0	7.0	Volts
Collector-Emitter Saturation Voltage	$V_{CE(sat)}$	$I_C = 200\text{A}, V_{GE} = 15V, T_j = 25^\circ\text{C}$	—	2.0	2.7	Volts
		$I_C = 200\text{A}, V_{GE} = 15V, T_j = 125^\circ\text{C}$	—	1.95	—	Volts
Total Gate Charge	$Q_G$	$V_{CC} = 300V, I_C = 200\text{A}, V_{GE} = 15V$	—	1240	—	nC
Emitter-Collector Voltage <sup>*1</sup>	$V_{EC}$	$I_E = 100\text{A}, V_{GE} = 0V$	—	—	4.0	Volts
Input Capacitance	$C_{ies}$	$V_{CE} = 10V, V_{GE} = 0V$	—	—	55	nf
Output Capacitance	$C_{oes}$		—	—	3.6	nf
Reverse Transfer Capacitance	$C_{res}$		—	—	2.0	nf
Turn-on Delay Time	$t_{d(on)}$		—	—	250	ns
Turn-on Rise Time	$t_r$	$V_{CC} = 300V, I_C = 200\text{A},$	—	—	150	ns
Turn-off Delay Time	$t_{d(off)}$	$V_{GE1} = V_{GE2} = 15V, R_G = 6.3\Omega,$	—	—	500	ns
Turn-off Fall Time	$t_f$	Inductive Load Switching Operation,	—	—	150	ns
Diode Reverse Recovery Time <sup>*1</sup>	$t_{rr}$	$I_E = 200\text{A}$	—	—	100	ns
Diode Reverse Recovery Charge <sup>*1</sup>	$Q_{rr}$		—	1.7	—	$\mu\text{C}$

\*1 Represent ratings and characteristics of the anti-parallel, emitter-to-collector free wheeling diode (FWDI).

**CM200CU-12NFH**  
**Dual IGBT NFH-Series Module**  
 200 Amperes/600 Volts

**Thermal and Mechanical Characteristics,  $T_j = 25\text{ }^\circ\text{C}$  unless otherwise specified**

Characteristics	Symbol	Test Conditions	Min.	Typ.	Max.	Units
Thermal Resistance Junction to Case	$R_{th(j-c)Q}$	Per IGBT 1/2 Module, TC Reference Point per Outline Drawing	—	—	0.21	$^\circ\text{C/W}$
Thermal Resistance Junction to Case	$R_{th(j-c)D}$	Per FWDi 1/2 Module, TC Reference Point per Outline Drawing	—	—	0.35	$^\circ\text{C/W}$
Thermal Resistance Junction to Case	$R_{th(j-c)'Q}$	Per IGBT 1/2 Module, TC reference Point Under Chips	—	—	0.15	$^\circ\text{C/W}$
Contact Thermal Resistance	$R_{th(c-f)}$	Per 1/2 Module, Thermal Grease Applied	—	0.07	—	$^\circ\text{C/W}$
External Gate Resistance	$R_G$		3.1	—	31	$\Omega$

**CM200CU-12NFH**  
**Dual IGBT NFH-Series Module**  
 200 Amperes/600 Volts

**OUTPUT CHARACTERISTICS (TYPICAL)**

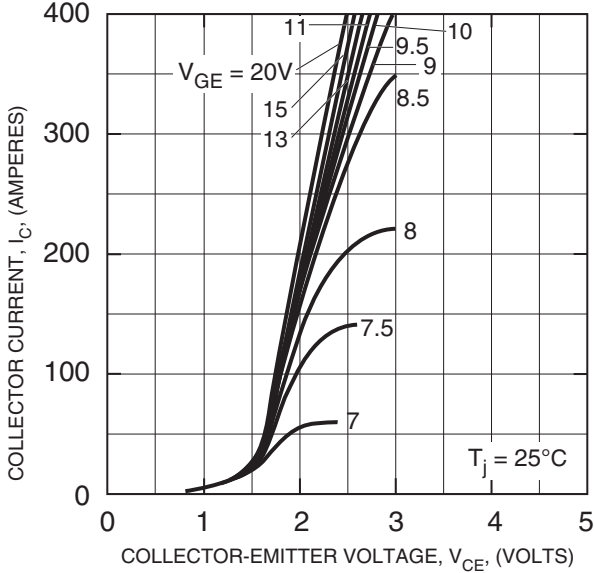

**COLLECTOR-EMITTER SATURATION VOLTAGE CHARACTERISTICS (TYPICAL)**

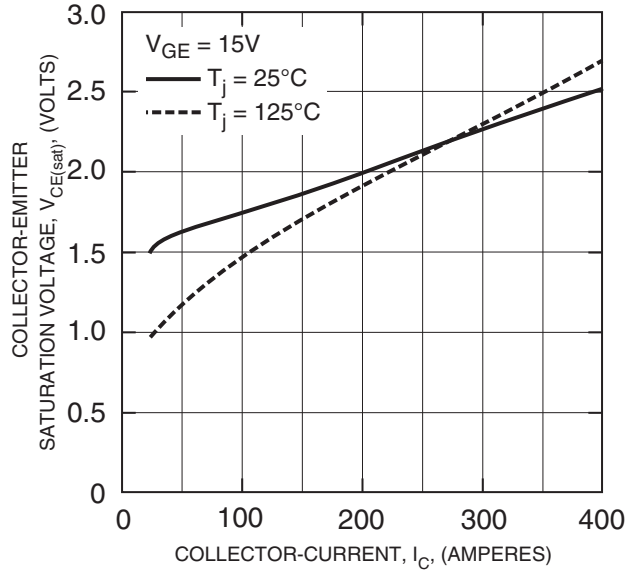

**COLLECTOR-EMITTER SATURATION VOLTAGE CHARACTERISTICS (TYPICAL)**

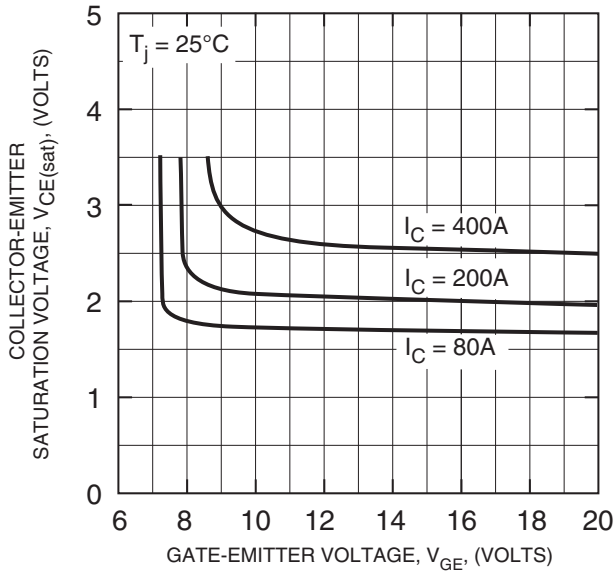

**FREE-WHEEL DIODE FORWARD CHARACTERISTICS (TYPICAL)**

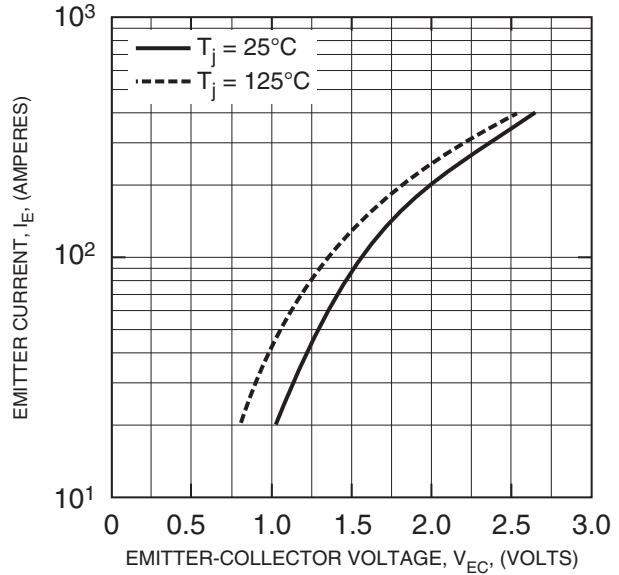

**CM200CU-12NFH**  
**Dual IGBT NFH-Series Module**  
 200 Amperes/600 Volts

**CAPACITANCE VS.  $V_{CE}$**   
(TYPICAL)

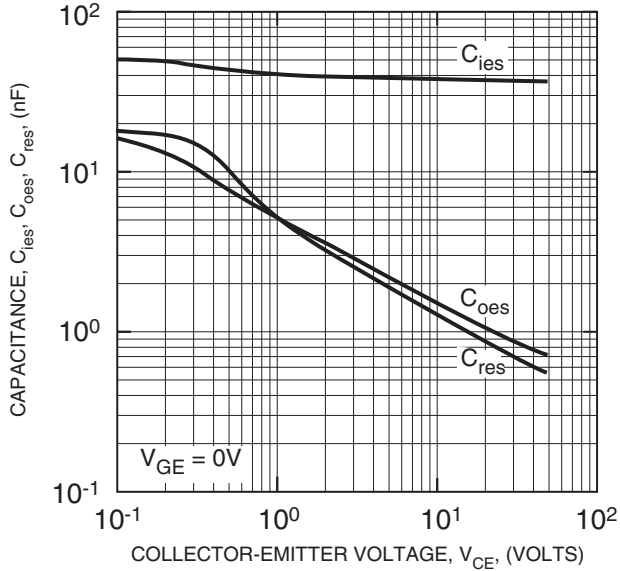

**HALF-BRIDGE SWITCHING CHARACTERISTICS**  
(TYPICAL)

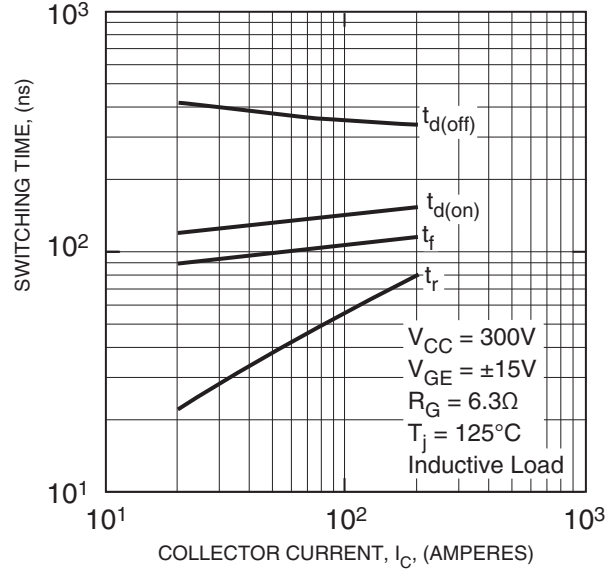

**REVERSE RECOVERY CHARACTERISTICS**  
(TYPICAL)

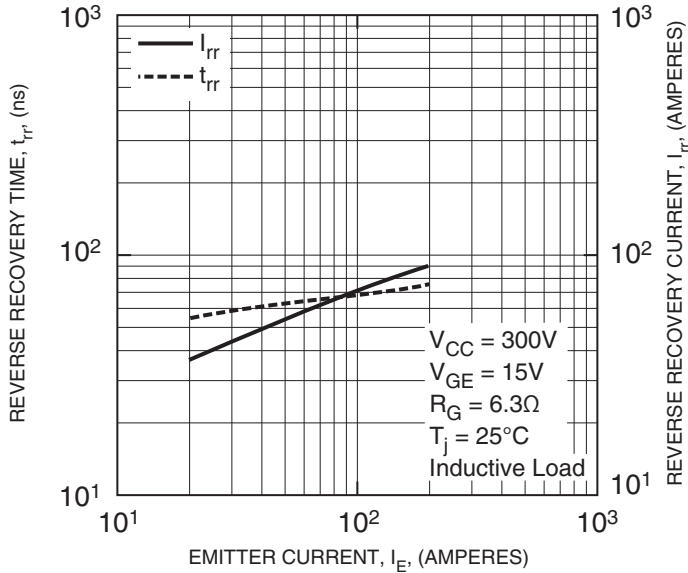

**GATE CHARGE VS.  $V_{GE}$**

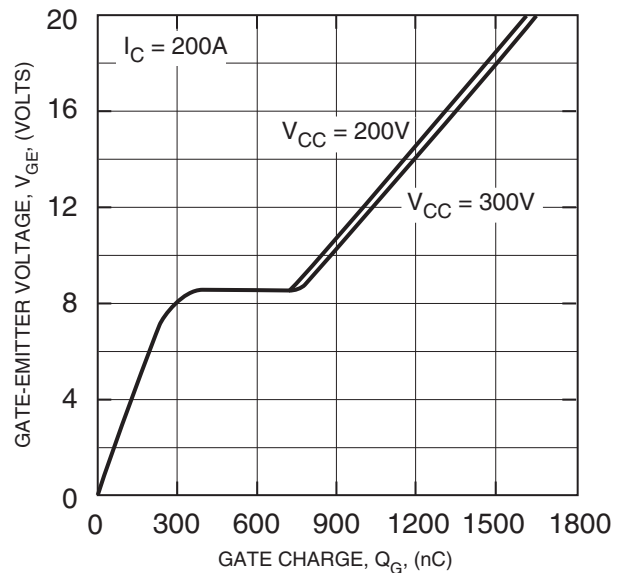

**CM200CU-12NFH**  
**Dual IGBT NFH-Series Module**  
 200 Amperes/600 Volts

**SWITCHING LOSS VS. COLLECTOR CURRENT (TYPICAL)**

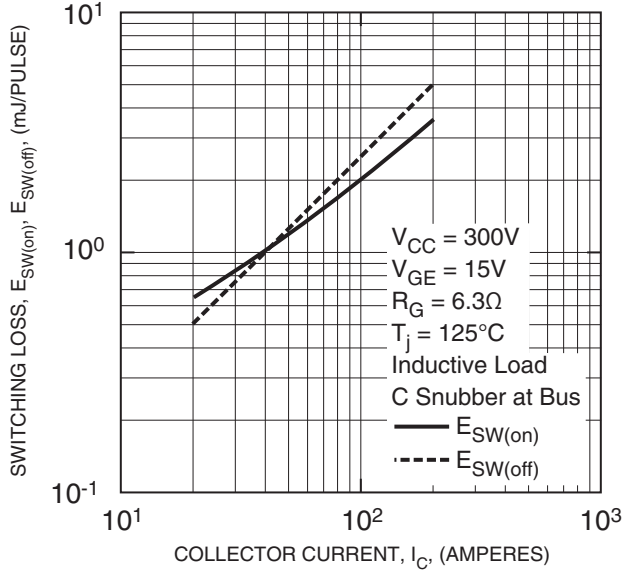

**SWITCHING LOSS VS. GATE RESISTANCE (TYPICAL)**

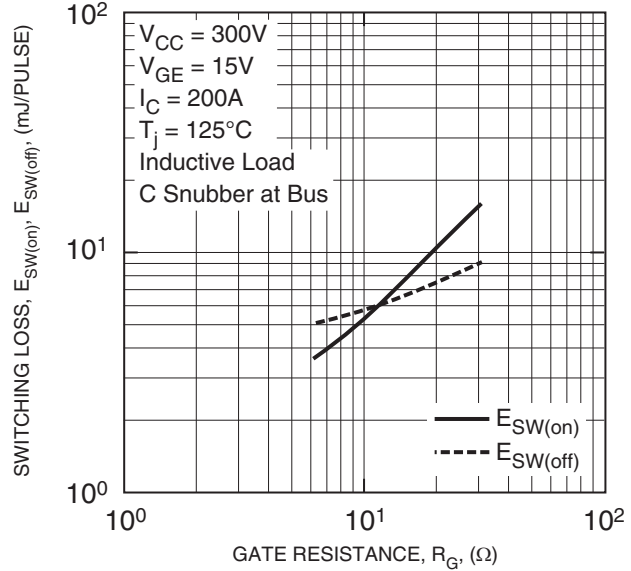

**REVERSE RECOVERY SWITCHING LOSS VS. EMITTER CURRENT (TYPICAL)**

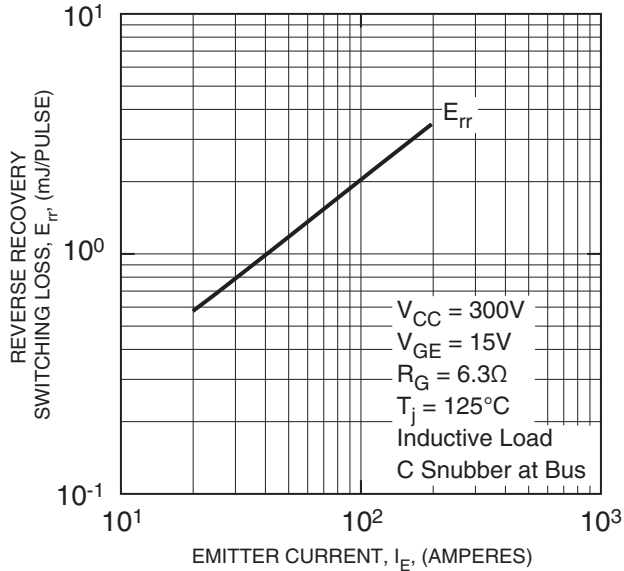

**REVERSE RECOVERY SWITCHING LOSS VS. GATE RESISTANCE (TYPICAL)**

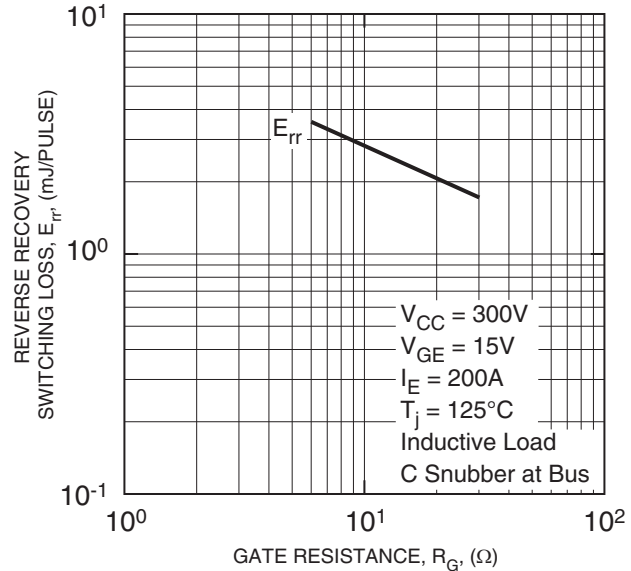

**CM200CU-12NFH**  
**Dual IGBT NFH-Series Module**  
 200 Amperes/600 Volts

