

# MITSUBISHI IGBT MODULES

## CM100E3U-12H

HIGH POWER SWITCHING USE  
INSULATED TYPE

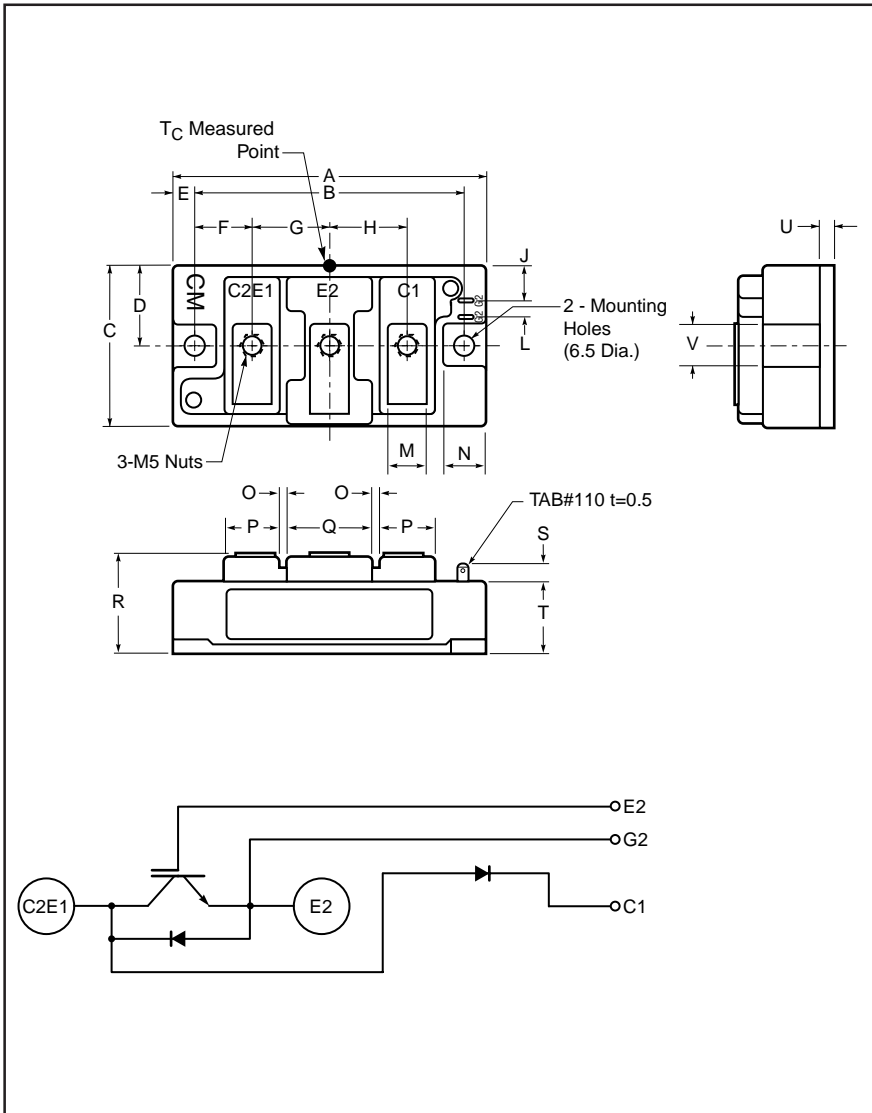

### Description:

Mitsubishi IGBT Modules are designed for use in switching applications. Each module consists of one IGBT having a reverse-connected super-fast recovery free-wheel diode and an anode-collector connected super-fast recovery free-wheel diode. All components and interconnects are isolated from the heat sinking baseplate, offering simplified system assembly and thermal management.

### Features:

- Low Drive Power
- Low  $V_{CE(sat)}$
- Discrete Super-Fast Recovery Free-Wheel Diode
- High Frequency Operation
- Isolated Baseplate for Easy Heat Sinking

### Application:

- Brake

### Ordering Information:

Example: Select the complete module number you desire from the table - i.e. CM100E3U-12H is a 600V ( $V_{CES}$ ), 100 Ampere IGBT Module.

### Outline Drawing and Circuit Diagram

Dimensions	Inches	Millimeters
A	3.7	94.0
B	3.15±0.01	80.0±0.25
C	1.89	48.0
D	0.94	24.0
E	0.28	7.0
F	0.67	17.0
G	0.91	23.0
H	0.91	23.0
J	0.43	11.0
L	0.16	4.0

Dimensions	Inches	Millimeters
M	0.47	12.0
N	0.53	13.5
O	0.1	2.5
P	0.63	16.0
Q	0.98	25.0
R	1.18 +0.04/-0.02	30.0 +1.0/-0.5
S	0.3	7.5
T	0.83	21.2
U	0.16	4.0
V	0.51	13.0

Type	Current Rating Amperes	$V_{CES}$ Volts (x 50)
CM	100	12

## CM100E3U-12H

HIGH POWER SWITCHING USE  
INSULATED TYPEAbsolute Maximum Ratings,  $T_j = 25\text{ }^\circ\text{C}$  unless otherwise specified

	Symbol	Ratings	Units
Junction Temperature	$T_j$	-40 to 150	$^\circ\text{C}$
Storage Temperature	$T_{stg}$	-40 to 125	$^\circ\text{C}$
Collector-Emitter Voltage (G-E SHORT)	$V_{CES}$	600	Volts
Gate-Emitter Voltage (C-E SHORT)	$V_{GES}$	$\pm 20$	Volts
Collector Current ( $T_c = 25^\circ\text{C}$ )	$I_C$	100	Amperes
Peak Collector Current	$I_{CM}$	200*	Amperes
Emitter Current** ( $T_c = 25^\circ\text{C}$ )	$I_E$	100	Amperes
Peak Emitter Current**	$I_{EM}$	200*	Amperes
Maximum Collector Dissipation ( $T_c = 25^\circ\text{C}$ , $T_j = 150^\circ\text{C}$ )	$P_C$	400	Watts
Mounting Torque, M5 Main Terminal	–	2.5–3.5	N · m
Mounting Torque, M6 Mounting	–	3.5–4.5	N · m
Weight	–	310	Grams
Isolation Voltage (Main Terminal to Baseplate, AC 1 min.)	$V_{iso}$	2500	Vrms

\* Pulse width and repetition rate should be such that the device junction temperature ( $T_j$ ) does not exceed  $T_{j(max)}$  rating.

\*\*Represents characteristics of the anti-parallel, emitter-to-collector free-wheel diode (FWDi).

Static Electrical Characteristics,  $T_j = 25\text{ }^\circ\text{C}$  unless otherwise specified

Characteristics	Symbol	Test Conditions	Min.	Typ.	Max.	Units
Collector-Cutoff Current	$I_{CES}$	$V_{CE} = V_{CES}$ , $V_{GE} = 0V$	–	–	1	mA
Gate Leakage Voltage	$I_{GES}$	$V_{GE} = V_{GES}$ , $V_{CE} = 0V$	–	–	0.5	$\mu\text{A}$
Gate-Emitter Threshold Voltage	$V_{GE(th)}$	$I_C = 10\text{mA}$ , $V_{CE} = 10V$	4.5	6	7.5	Volts
Collector-Emitter Saturation Voltage	$V_{CE(sat)}$	$I_C = 100\text{A}$ , $V_{GE} = 15V$ , $T_j = 25^\circ\text{C}$	–	2.4	3.0	Volts
		$I_C = 100\text{A}$ , $V_{GE} = 15V$ , $T_j = 125^\circ\text{C}$	–	2.6	–	Volts
Total Gate Charge	$Q_G$	$V_{CC} = 300V$ , $I_C = 100\text{A}$ , $V_{GE} = 15V$	–	200	–	nC
Emitter-Collector Voltage**	$V_{EC}$	$I_E = 100\text{A}$ , $V_{GE} = 0V$	–	–	2.6	Volts
Emitter-Collector Voltage	$V_{FM}$	$I_F = 100\text{A}$ , Clamp Diode Part	–	–	2.6	Volts

\*\*Represents characteristics of the anti-parallel, emitter-to-collector free-wheel diode (FWDi).

Dynamic Electrical Characteristics,  $T_j = 25\text{ }^\circ\text{C}$  unless otherwise specified

Characteristics	Symbol	Test Conditions	Min.	Typ.	Max.	Units
Input Capacitance	$C_{ies}$		–	–	8.8	nF
Output Capacitance	$C_{oes}$	$V_{CE} = 10V$ , $V_{GE} = 0V$	–	–	4.8	nF
Reverse Transfer Capacitance	$C_{res}$		–	–	1.3	nF
Resistive	Turn-on Delay Time	$V_{CC} = 300V$ , $I_C = 100\text{A}$ , $V_{GE1} = V_{GE2} = 15V$ ,	–	–	100	ns
	Rise Time					
Load	Turn-off Delay Time	$R_G = 6.3\Omega$ , Resistive	–	–	250	ns
	Fall Time					
Switch	Turn-off Delay Time	$R_G = 6.3\Omega$ , Resistive	–	–	200	ns
Times	Fall Time	Load Switching Operation	–	–	300	ns
Diode Reverse Recovery Time**	$t_{rr}$	$I_E = 100\text{A}$ , $di_E/dt = -200\text{A}/\mu\text{s}$	–	–	160	ns
Diode Reverse Recovery Charge**	$Q_{rr}$	$I_E = 100\text{A}$ , $di_E/dt = -200\text{A}/\mu\text{s}$	–	0.24	–	$\mu\text{C}$
Diode Reverse Recovery Time	$t_{rr}$	$I_F = 100\text{A}$ , Clamp Diode Part	–	–	160	ns
Diode Reverse Recovery Charge	$Q_{rr}$	$di_F/dt = -200\text{A}/\mu\text{s}$	–	0.24	–	$\mu\text{C}$

\*\*Represents characteristics of the anti-parallel, emitter-to-collector free-wheel diode (FWDi).

# CM100E3U-12H

HIGH POWER SWITCHING USE  
INSULATED TYPE

## Thermal and Mechanical Characteristics, $T_j = 25\text{ }^\circ\text{C}$ unless otherwise specified

Characteristics	Symbol	Test Conditions	Min.	Typ.	Max.	Units
Thermal Resistance, Junction to Case	$R_{th(j-c)Q}$	Per IGBT	–	–	0.31	$^\circ\text{C/W}$
Thermal Resistance, Junction to Case	$R_{th(j-c)D}$	Per FWDi	–	–	0.7	$^\circ\text{C/W}$
Thermal Resistance, Junction to Case	$R_{th(j-c)}$	Clamp Diode Part	–	–	0.7	$^\circ\text{C/W}$
Contact Thermal Resistance	$R_{th(c-f)}$	Per Module, Thermal Grease Applied	–	0.035	–	$^\circ\text{C/W}$

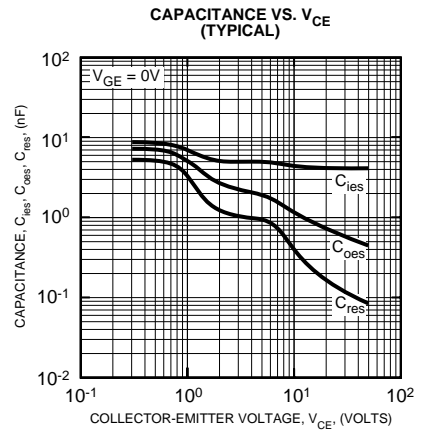
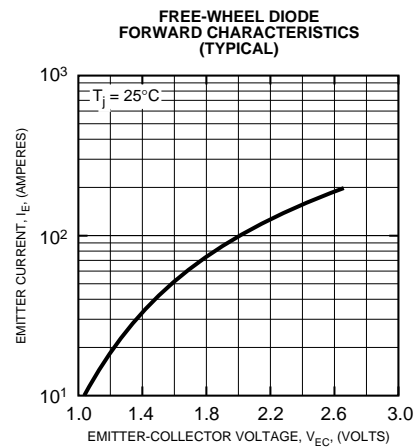
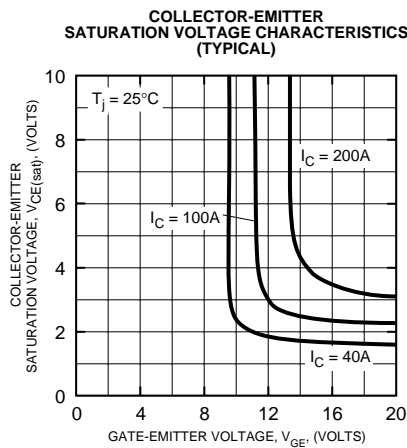
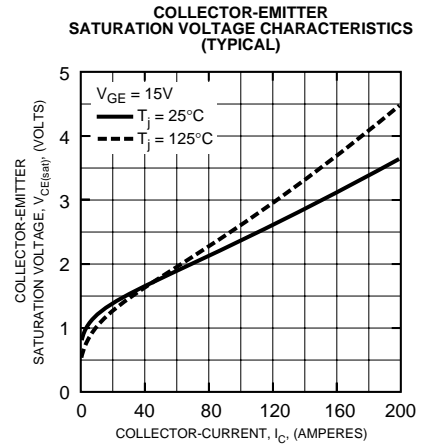
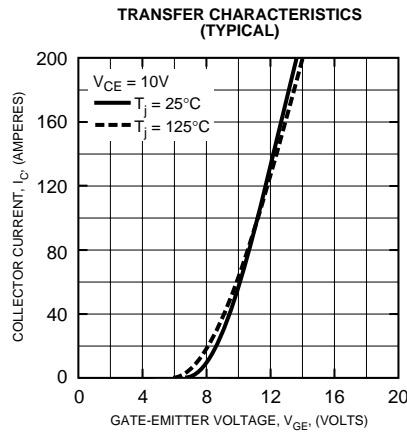
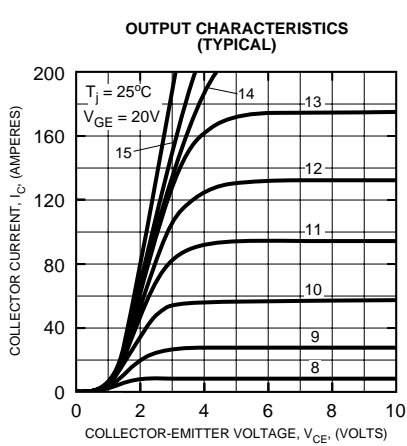

# CM100E3U-12H

HIGH POWER SWITCHING USE  
INSULATED TYPE

**HALF-BRIDGE SWITCHING CHARACTERISTICS (TYPICAL)**

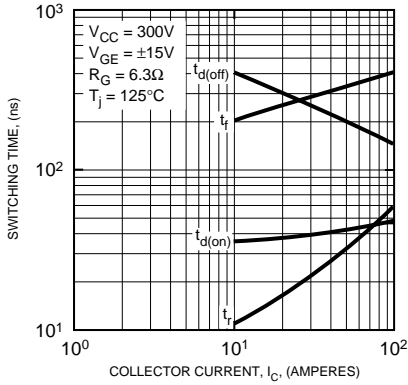

**REVERSE RECOVERY CHARACTERISTICS (TYPICAL)**

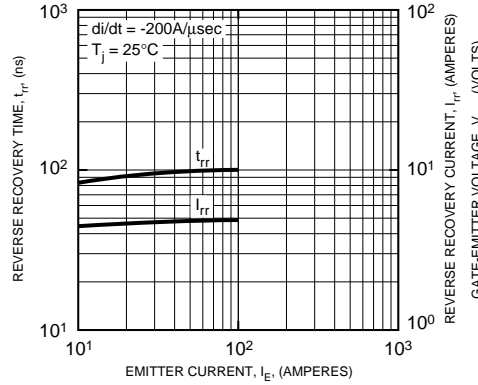

**GATE CHARGE,  $V_{GE}$**

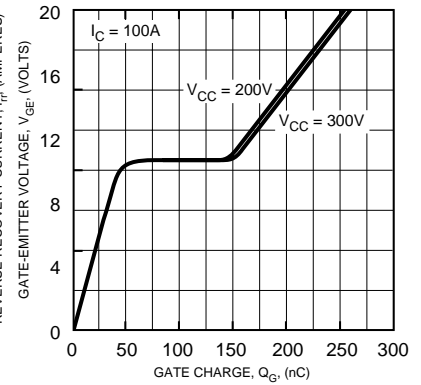

**TRANSIENT THERMAL IMPEDANCE CHARACTERISTICS (IGBT)**

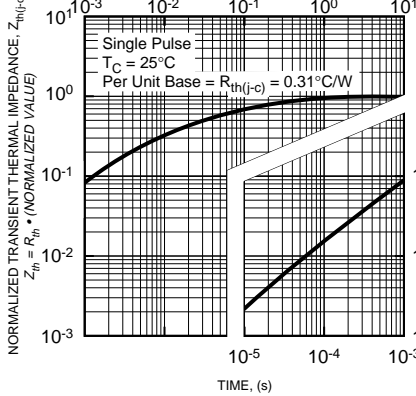

**TRANSIENT THERMAL IMPEDANCE CHARACTERISTICS (FWDi)**

