

6MBI300U-120



IGBT Module U-Series 1200V / 300A 6 in one-package

■ Features

- High speed switching
- Voltage drive
- Low inductance module structure

■ Applications

- Inverter for Motor drive
- AC and DC Servo drive amplifier
- Uninterruptible power supply
- Industrial machines, such as Welding machines

■ Maximum ratings and characteristics

● Absolute maximum ratings (at Tc=25°C unless otherwise specified)

Item	Symbol	Conditions	Rating	Unit	
Collector-Emitter voltage	V _{CES}		1200	V	
Gate-Emitter voltage	V _{GES}		±20	V	
Collector current	I _c	Continuous	T _c =25°C	450	A
			T _c =80°C	300	
	I _{cp}	1ms	T _c =25°C	900	
			T _c =80°C	600	
	-I _c			300	
-I _c pulse			600		
Collector Power Dissipation	P _c	1 device	1385	W	
Junction temperature	T _j		+150	°C	
Storage temperature	T _{stg}		-40 to +125		
Isolation voltage	between terminal and copper base *1	V _{iso}	AC:1min.	2500	VAC
	between thermistor and others *2				
Screw Torque	Mounting *3	-		3.5	N·m
	Terminals *4				

*1 : All terminals should be connected together when isolation test will be done.

*2 : Two thermistor terminals should be connected together, each other terminals should be connected together and shorted to base plate when isolation test will be done.

*3 : Recommendable value : 2.5 to 3.5 N·m(M5) *4 : Recommendable value : 3.5 to 4.5 N·m(M6)

● Electrical characteristics (at Tj=25°C unless otherwise specified)

Item	Symbols	Conditions	Characteristics			Unit	
			Min.	Typ.	Max.		
Zero gate voltage collector current	ICES	V _{GE} =0V, V _{CES} =1200V	-	-	3.0	mA	
Gate-Emitter leakage current	IGES	V _{CES} =0V, V _{GE} =±20V	-	-	600	nA	
Gate-Emitter threshold voltage	V _{GE(th)}	V _{CES} =20V, I _c =300mA	4.5	6.5	8.5	V	
Collector-Emitter saturation voltage	V _{CE(sat)} (terminal)	V _{GE} =15V, I _c =300A	T _j =25°C	-	2.05	2.40	V
			T _j =125°C	-	2.30	-	
	V _{CE(sat)} (chip)		T _j =25°C	-	1.75	2.10	
			T _j =125°C	-	2.00	-	
Input capacitance	C _{ies}	V _{CES} =10V, V _{GE} =0V, f=1MHz	-	34	-	nF	
Turn-on time	t _{on}	V _{CC} =600V	-	0.36	1.20	μs	
	t _r	I _c =300A	-	0.21	0.60		
	t _{r(i)}	V _{GE} =±15V	-	0.03	-		
Turn-off time	t _{off}	R _G =2 Ω	-	0.37	1.00	μs	
	t _f		-	0.07	0.30		
Forward on voltage	V _F (terminal)	V _{GE} =0V I _F =300A	T _j =25°C	-	1.90	2.20	V
			T _j =125°C	-	2.00	-	
	V _F (chip)		T _j =25°C	-	1.60	1.90	
			T _j =125°C	-	1.70	-	
Reverse recovery time	t _{rr}	I _F =300A	-	-	0.35	μs	
Lead resistance, terminal-chip*4	R lead		-	1.0	-	mΩ	
Thermistor	Resistance	R	T=25°C	-	5000	-	Ω
			T=100°C	465	495	520	
	B value	B	T=25/50°C	3305	3375	3450	K

*4:Biggest internal terminal resistance among arm.

● Thermal resistance characteristics

Items	Symbols	Conditions	Characteristics			Unit
			Min.	Typ.	Max.	
Thermal resistance	R _{th(j-c)}	IGBT	-	-	0.09	°C/W
	R _{th(j-c)}	FWD	-	-	0.15	°C/W
Contact Thermal resistance	R _{th(c-f)} *5	With thermal compound	-	0.0167	-	°C/W

*5 : This is the value which is defined mounting on the additional cooling fin with thermal compound.

■ Characteristics (Representative)

Collector current vs. Collector-Emitter voltage (typ.)

T_j=25°C / chip

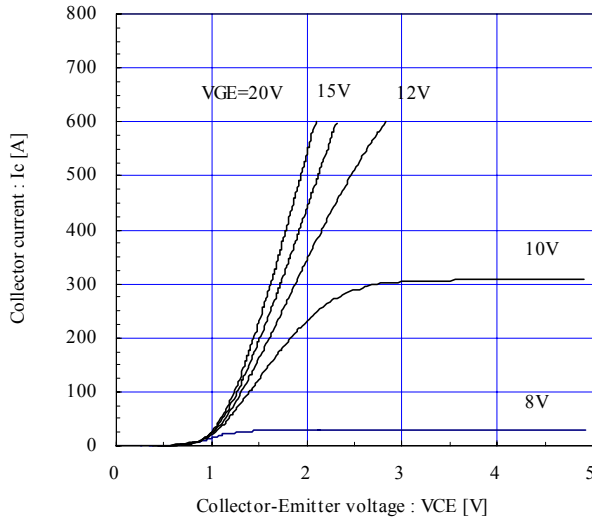

Collector current vs. Collector-Emitter voltage (typ.)

T_j=125°C / chip

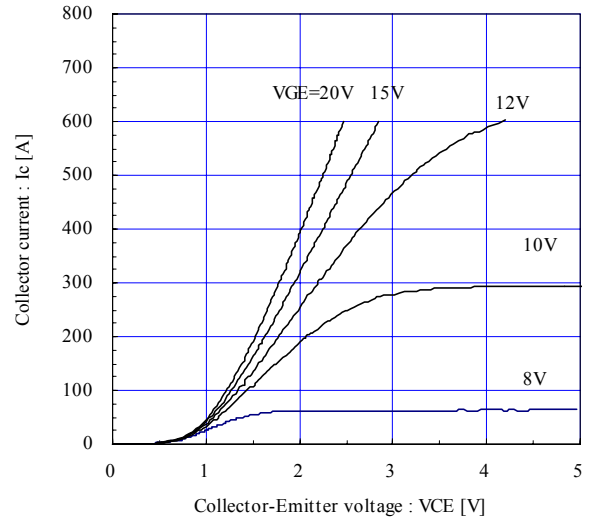

Collector current vs. Collector-Emitter voltage (typ.)

VGE=15V / chip

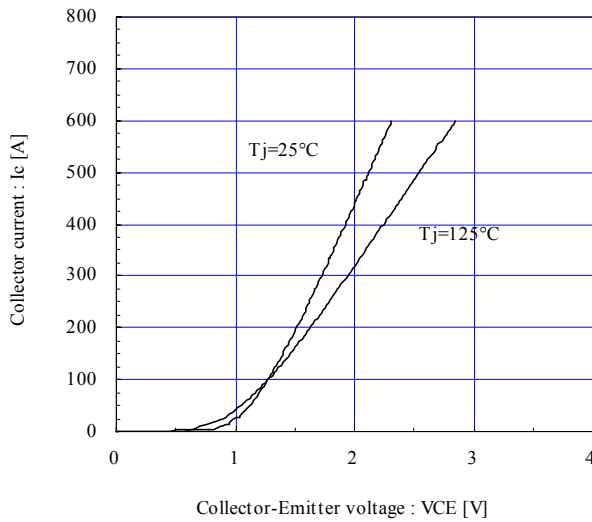

Collector-Emitter voltage vs. Gate-Emitter voltage (typ.)

T_j=25°C / chip

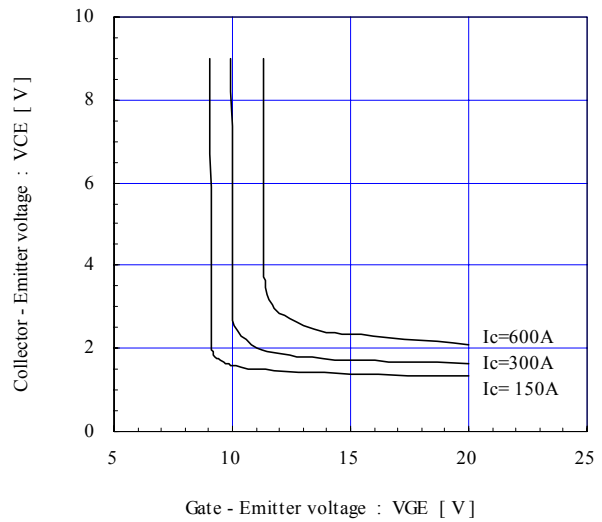

Capacitance vs. Collector-Emitter voltage (typ.)

VGE=0V, f=1MHz, Tj=25°C

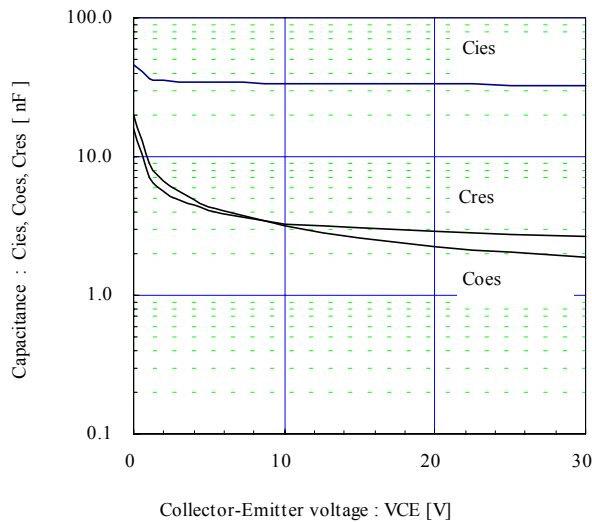

Dynamic Gate charge (typ.)

Vcc=600V, Ic=300A, Tj=25°C

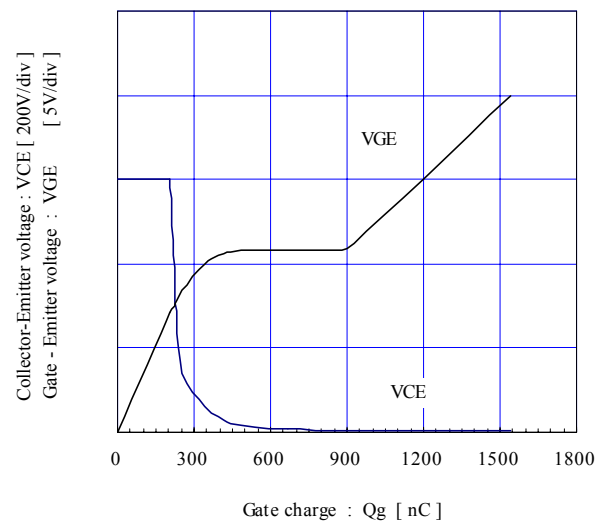

Switching time vs. Collector current (typ.)

V_{cc}=600V, V_{GE}=±15V, R_g=2Ω, T_j= 25°C

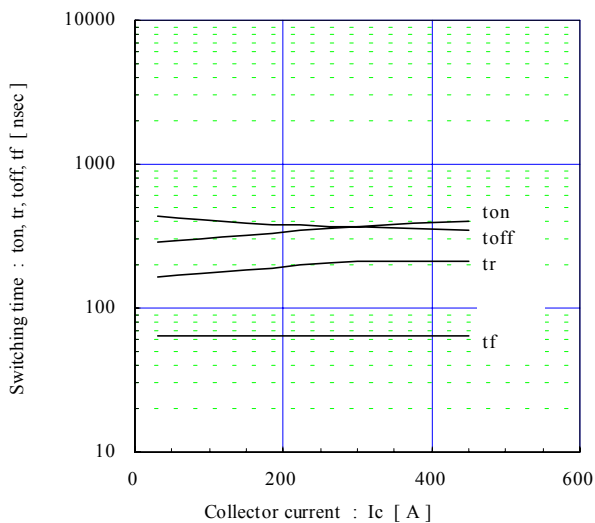

Switching time vs. Collector current (typ.)

V_{cc}=600V, V_{GE}=±15V, R_g=2Ω, T_j=125°C

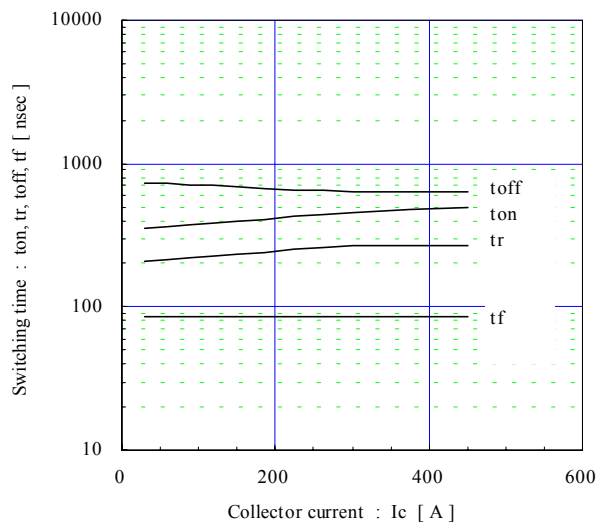

Switching time vs. Gate resistance (typ.)

V_{cc}=600V, I_c=300A, V_{GE}=±15V, T_j= 25°C

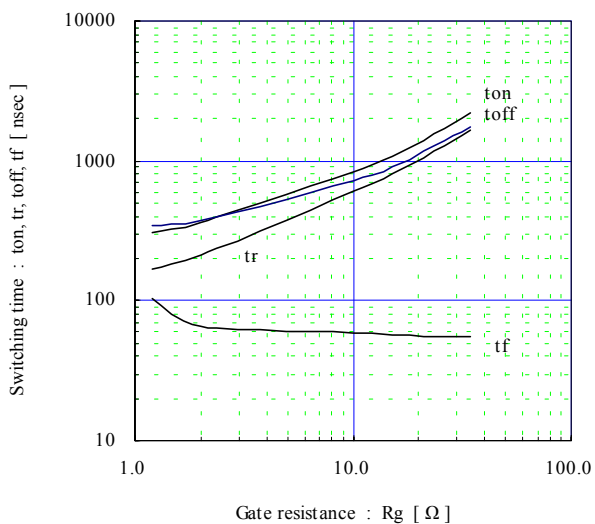

Switching loss vs. Collector current (typ.)

V_{cc}=600V, V_{GE}=±15V, R_g=2Ω

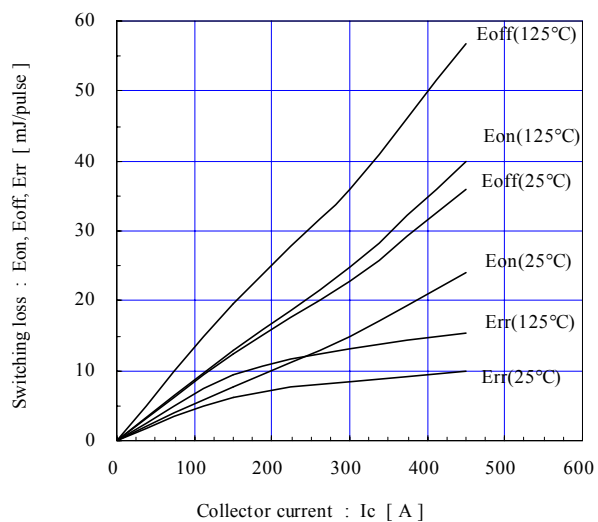

Switching loss vs. Gate resistance (typ.)

V_{cc}=600V, I_c=300A, V_{GE}=±15V, T_j= 125°C

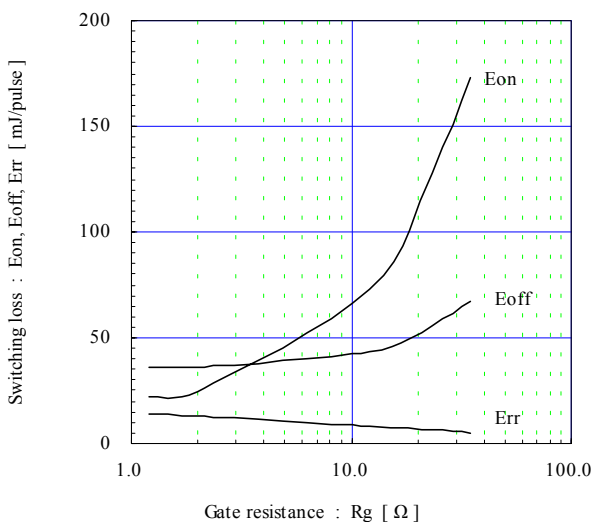

Reverse bias safe operating area (max.)

+V_{GE}=15V, -V_{GE} ≤ 15V, R_G ≥ 2Ω, T_j ≤ 125°C

Stray inductance ≤ 100nH

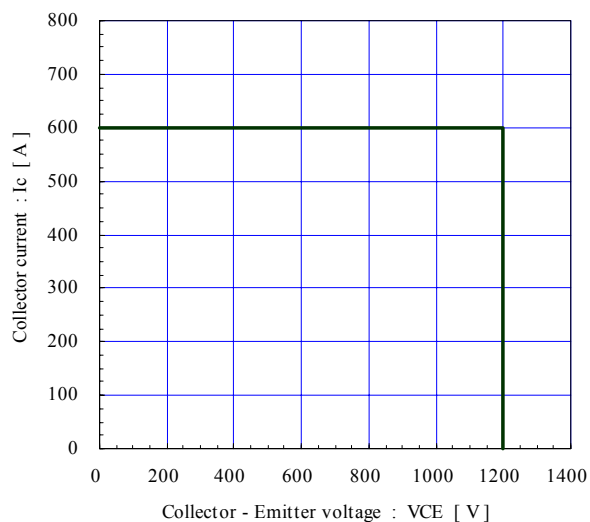

Forward current vs. Forward on voltage (typ.)
chip

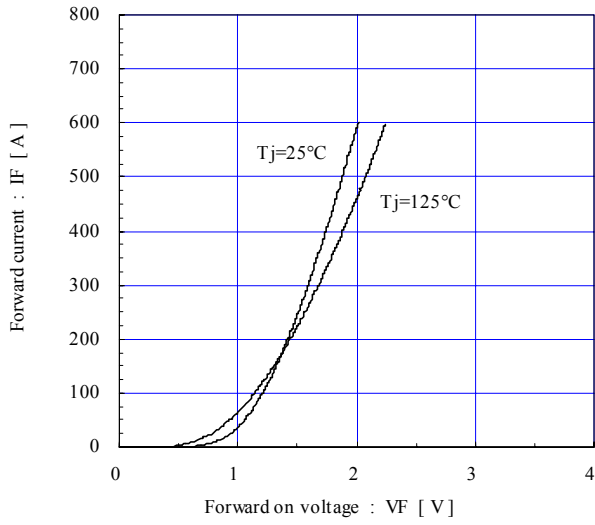

Reverse recovery characteristics (typ.)

$V_{cc}=600\text{V}$, $V_{GE}=\pm 15\text{V}$, $R_g=2\Omega$

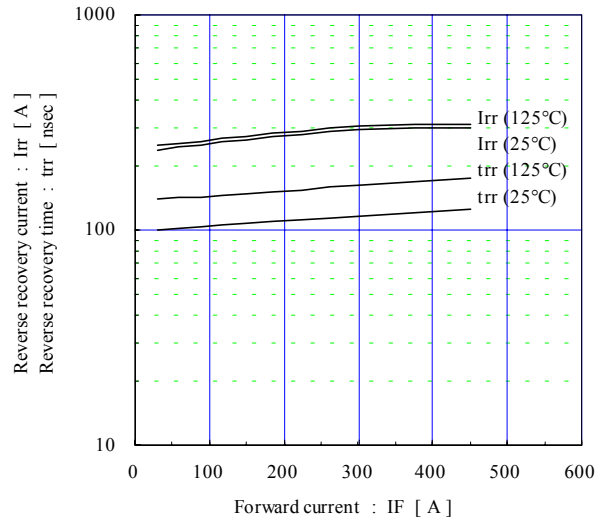

Transient thermal resistance (max.)

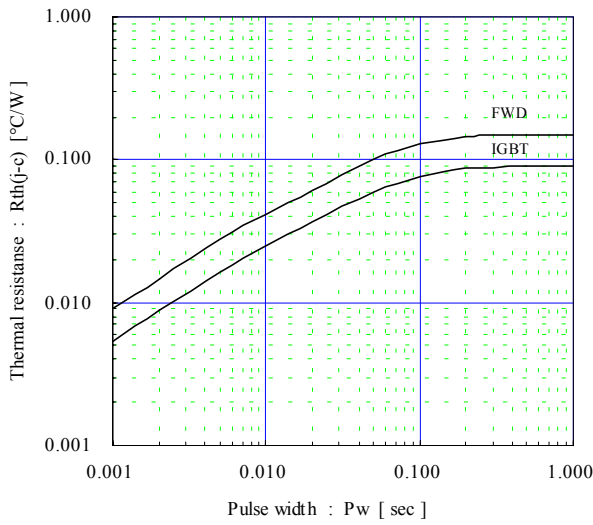

Temperature characteristic (typ.)

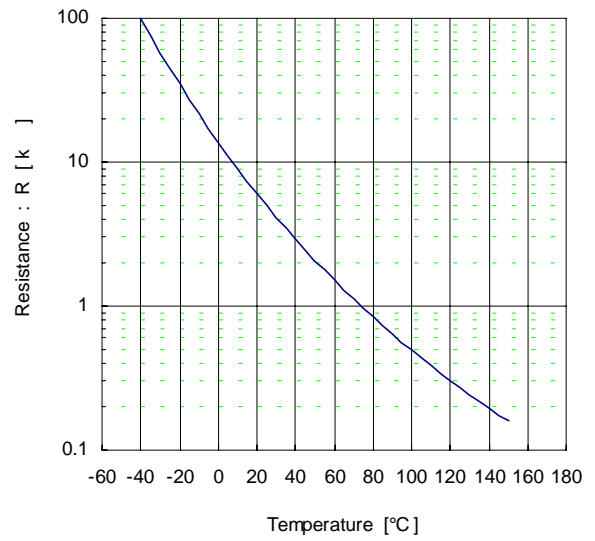

Outline Drawings, mm

M629

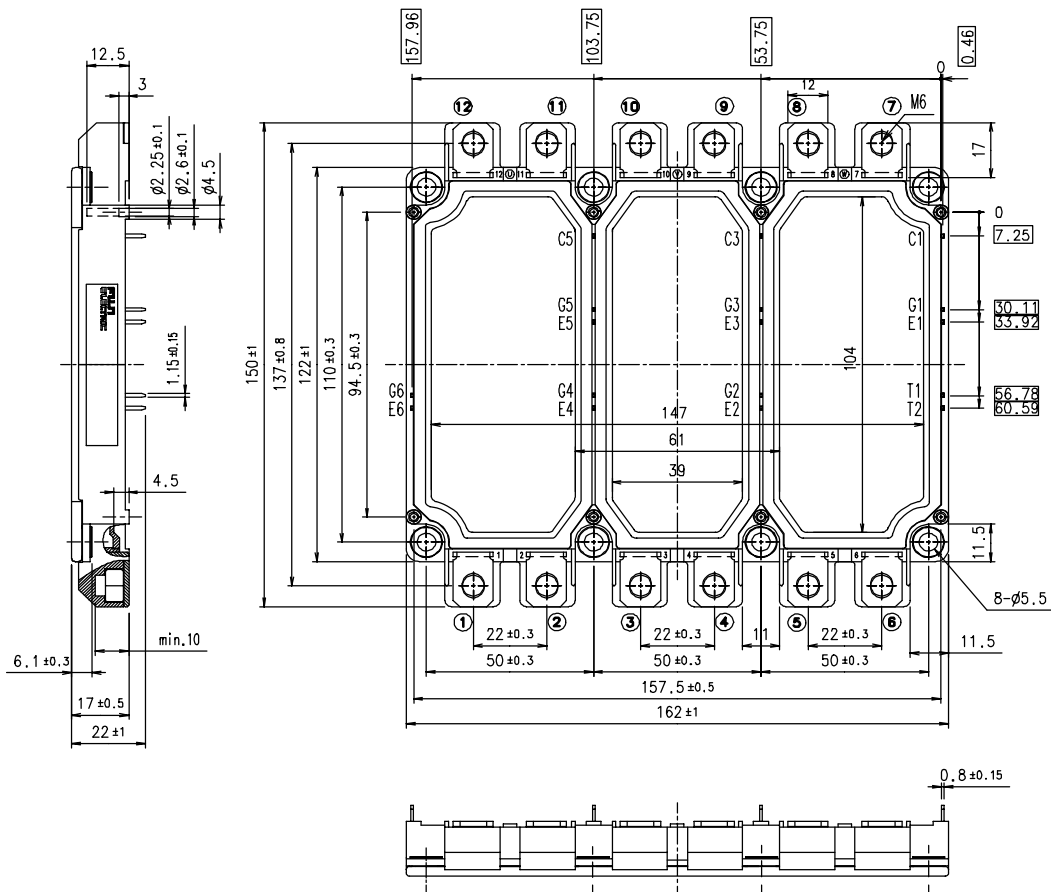

NOTE) shows theoretical dimension and tolerance is $\phi 0.5$.

Equivalent Circuit Schematic

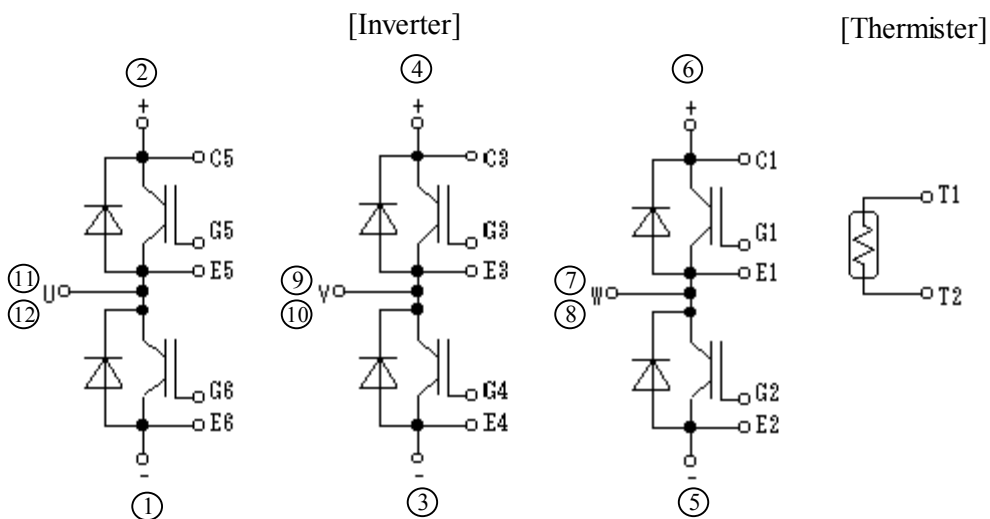

This datasheet has been downloaded from:

www.DatasheetCatalog.com

Datasheets for electronic components.