

Absolute Maximum Ratings		Values	Units
Symbol	Conditions ¹⁾		
V _{CES}		600	V
V _{CGR}	R _{GE} = 20 kΩ	600	V
I _C	T _{case} = 25/80 °C	250 / 190	A
I _{CM}	T _{case} = 25/80 °C; t _p = 1 ms	500 / 380	A
V _{GES}		± 20	V
P _{tot}	per IGBT, T _{case} = 25 °C	960	W
T _J , (T _{stg})		-40 ... +150 (125)	°C
V _{isol}	AC, 1 min.	2 500	V
humidity	IEC 60721-3-3	class 3K7/IE32	
climate	IEC 68 T.1	40/125/56	
Inverse Diode and FWD of type "GAL, GAR" ^(6) 8)			
I _F = -I _C	T _{case} = 25/80 °C	200 / 140	A
I _{FM} = -I _{CM}	T _{case} = 25/80 °C; t _p = 1 ms	500 / 380	A
I _{FSM}	t _p = 10 ms; sin.; T _J = 150 °C	1 400	A
I ² t	t _p = 10 ms; T _J = 150 °C	9800	A ² s

Characteristics		min.	typ.	max.	Units
Symbol	Conditions ¹⁾				
V _{(BR)CES}	V _{GE} = 0, I _C = 4 mA	≥ V _{CES}	-	-	V
V _{GE(th)}	V _{GE} = V _{CE} , I _C = 4 mA	4,5	5,5	6,5	V
I _{CES}	V _{GE} = 0 } T _J = 25 °C	-	0,2	-	mA
	V _{CE} = V _{CES} } T _J = 125 °C	-	7	-	mA
I _{GES}	V _{GE} = 20 V, V _{CE} = 0	-	-	0,3	μA
V _{CEsat}	I _C = 200 A } V _{GE} = 15 V;	-	2,1(2,4)	2,5(2,8)	V
	T _J = 25 (125) °C }	-	-	-	V
g _{fs}	V _{CE} = 20 V, I _C = 200 A	40	-	-	S
C _{CHC}	per IGBT	-	-	350	pF
C _{ies}	V _{GE} = 0	-	11,2	-	nF
C _{oes}	V _{CE} = 25 V	-	1250	-	pF
C _{res}	f = 1 MHz	-	750	-	pF
L _{CE}	(terminal 2 - 3)	-	-	25	nH
t _{d(on)}	V _{CC} = 300 V	-	120	-	ns
t _r	V _{GE} = +15 V / -15 V ³⁾	-	85	-	ns
t _{d(off)}	I _C = 200 A, ind. load	-	460	-	ns
t _f	R _{Gon} = R _{Goff} = 8 Ω	-	50	-	ns
E _{on}	T _J = 125 °C	-	11,5	-	mWs
E _{off}		-	7,5	-	mWs
Inverse Diode and FWD of type "GAL, GAR" ^(6) 8)					
V _F = V _{EC}	I _F = 150 A } V _{GE} = 0 V;	-	1,45(1,35)	1,7	V
V _F = V _{EC}	I _F = 200 A } T _J = 25 (125) °C }	-	1,55(1,55)	1,9	V
V _{TO}	T _J = 125 °C	-	-	0,9	V
r _t	T _J = 125 °C	-	4	5,5	mΩ
I _{RRM}	I _F = 200 A; T _J = 125 °C ²⁾	-	75	-	A
Q _{rr}	I _F = 200 A; T _J = 125 °C ²⁾	-	13	-	μC
Thermal characteristics					
R _{thjc}	per IGBT	-	-	0,13	°C/W
R _{thjc}	per diode	-	-	0,3	°C/W
R _{thch}	per module	-	-	0,05	°C/W

SEMITRANS® M Superfast NPT-IGBT Modules

SKM 195 GB 063 DN
SKM 195 GAL 063 DN ⁶⁾
SKM 195 GAR 063 DN ⁶⁾



SEMITRANS 2N (low inductance)

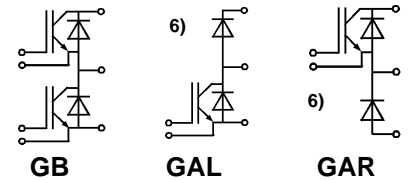

Features

- N channel, homogeneous Silicon structure (NPT-Non-Punch-through IGBT)
- Low tail current with low temperature dependence
- High short circuit capability, self limiting
- Pos. temp. coeff. of V_{CEsat}
- Low inductance case
- Fast & soft inverse CAL diodes ⁸⁾
- Without hard mould
- Large clearance (10 mm) and creepage distances (20 mm)

Typical Applications

- Switching (not for linear use)
- Switched mode power supplies
- AC inverter drives
- UPS uninterruptable power supplies

¹⁾ T_{case} = 25 °C, unless otherwise specified

²⁾ I_F = -I_C, V_R = 300 V, -di_F/dt = 1500 A/μs, V_{GE} = 0 V

³⁾ Use V_{GEoff} = -5 ... -15 V

⁴⁾ For switch-off of 2 * I_{CN} = 400 A use R_{goff} ≥ 12 Ω.

For switch-off of short circuit use R_{goff} ≥ 25 Ω.

⁶⁾ The free-wheeling diodes of the GAL type have the data of the inverse diodes.

⁸⁾ CAL = Controlled Axial Lifetime Technology

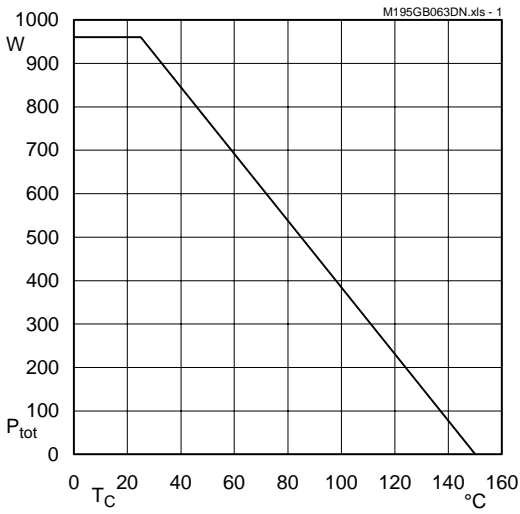

Fig. 1 Rated power dissipation $P_{tot} = f(T_C)$

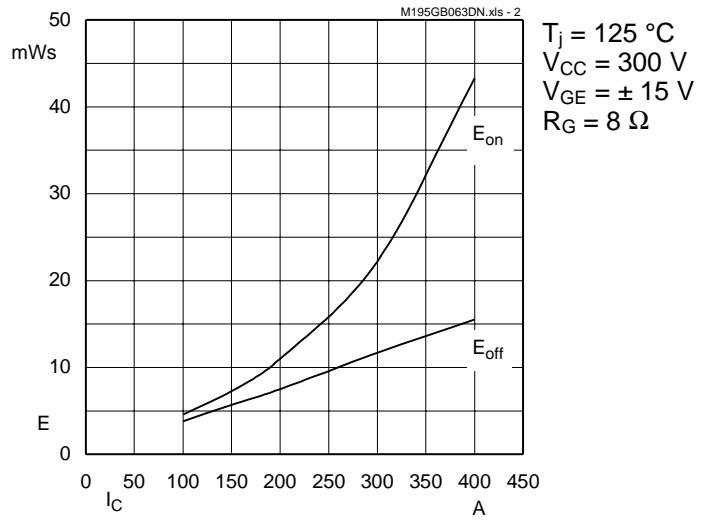

Fig. 2 Turn-on /-off energy $E = f(I_C)$

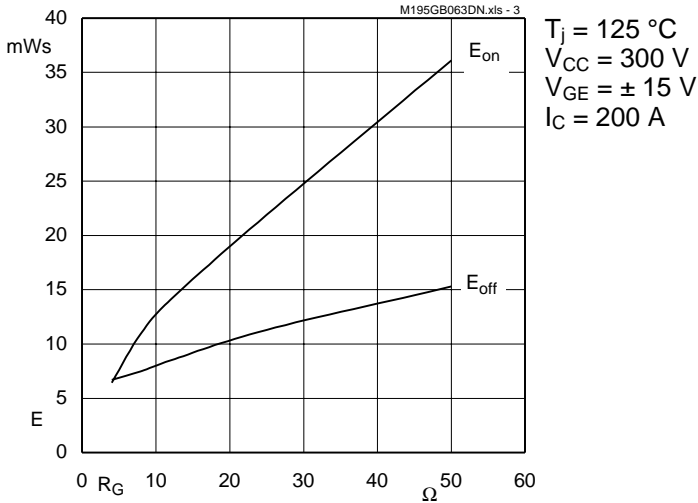

Fig. 3 Turn-on /-off energy $E = f(R_G)$

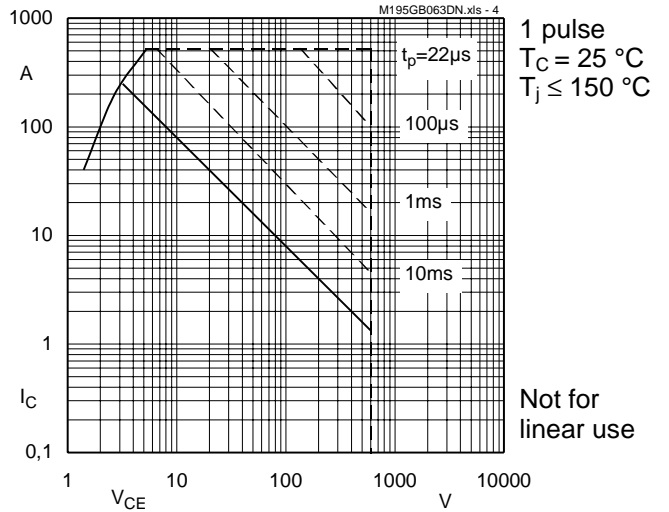

Fig. 4 Maximum safe operating area (SOA) $I_C = f(V_{CE})$

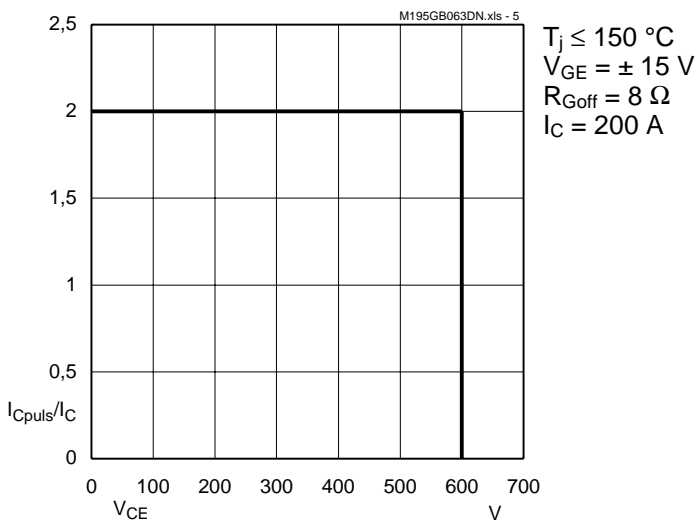

Fig. 5 Turn-off safe operating area (RBSOA)

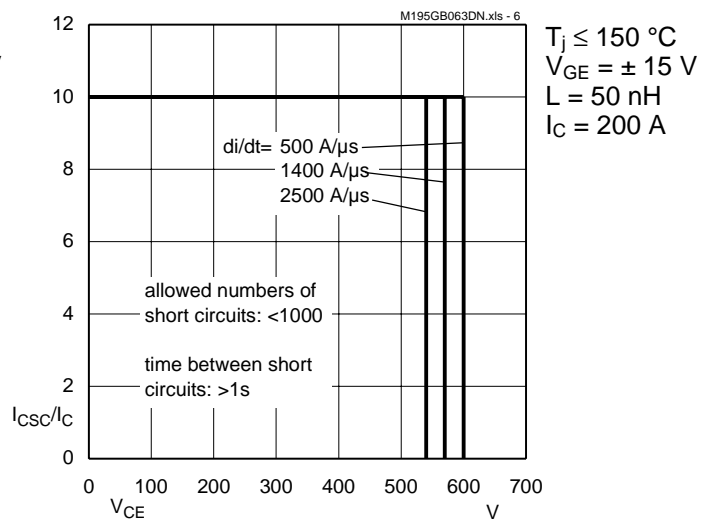

Fig. 6 Safe operating area at short circuit $I_C = f(V_{CE})$

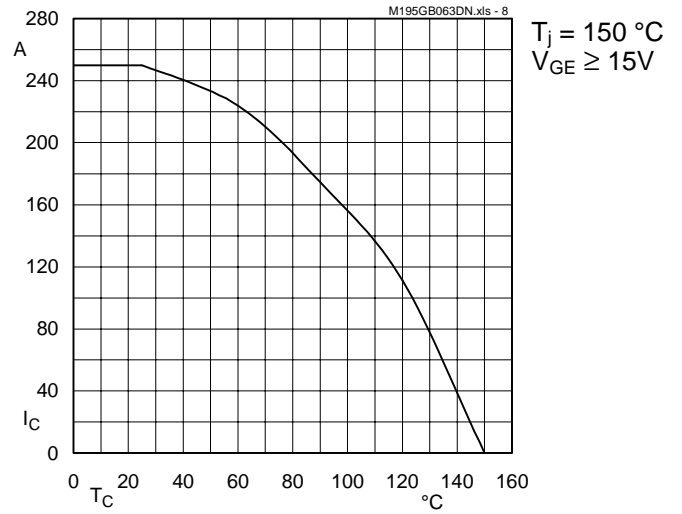

Fig. 8 Rated current vs. temperature $I_C = f(T_C)$

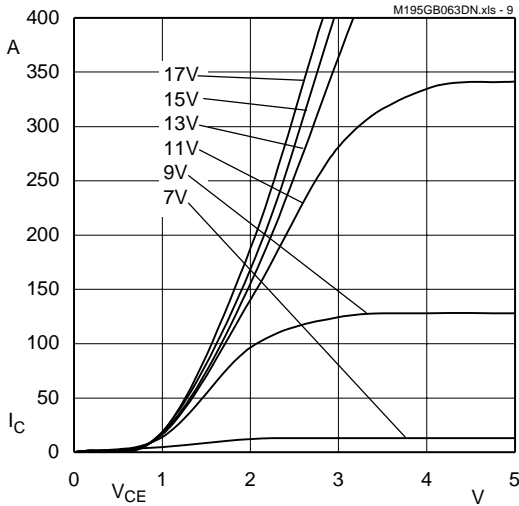

Fig. 9 Typ. output characteristic, $t_p = 250\text{ }\mu\text{s}$; $T_j = 25\text{ }^\circ\text{C}$

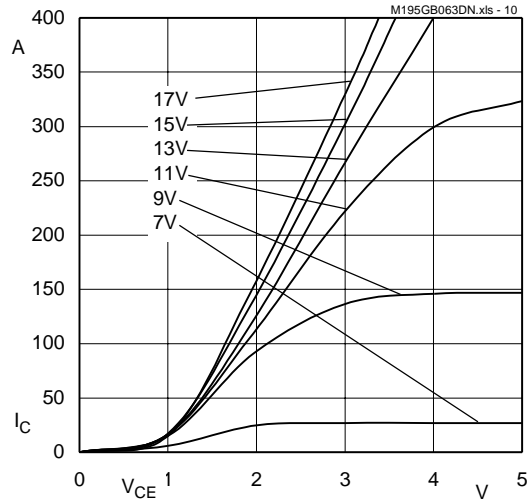

Fig. 10 Typ. output characteristic, $t_p = 250\text{ }\mu\text{s}$; $T_j = 125\text{ }^\circ\text{C}$

$$P_{\text{cond}(t)} = V_{\text{CEsat}(t)} \cdot I_{\text{C}(t)}$$

$$V_{\text{CEsat}(t)} = V_{\text{CE(TO)(Tj)}} + r_{\text{CE(Tj)}} \cdot I_{\text{C}(t)}$$

$$V_{\text{CE(TO)(Tj)}} \leq 1,2 - 0,001 (T_j - 25) \text{ [V]}$$

$$\text{typ.: } r_{\text{CE(Tj)}} = 0,0045 + 0,00002 (T_j - 25) \text{ [\Omega]}$$

$$\text{max.: } r_{\text{CE(Tj)}} = 0,0065 + 0,00002 (T_j - 25) \text{ [\Omega]}$$

$$\text{valid for } V_{\text{GE}} = +15 \frac{+2}{-1} \text{ [V]; } I_{\text{C}} \geq 0,3 I_{\text{Cn}}$$

Fig. 11 Saturation characteristic (IGBT)
Calculation elements and equations

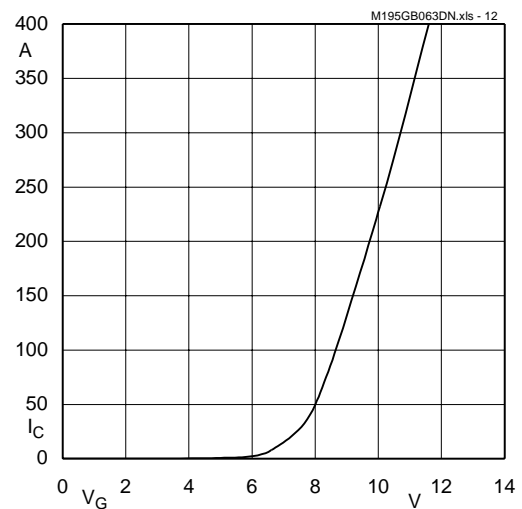

Fig. 12 Typ. transfer characteristic, $t_p = 250\text{ }\mu\text{s}$; $V_{\text{CE}} = 20\text{ V}$

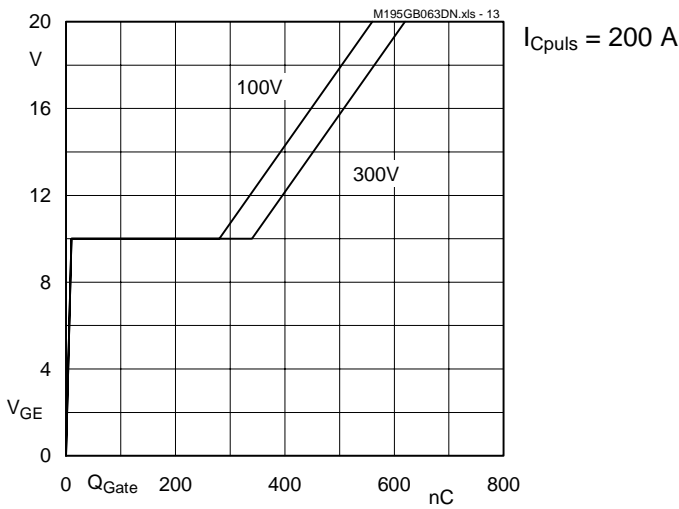

Fig. 13 Typ. gate charge characteristic

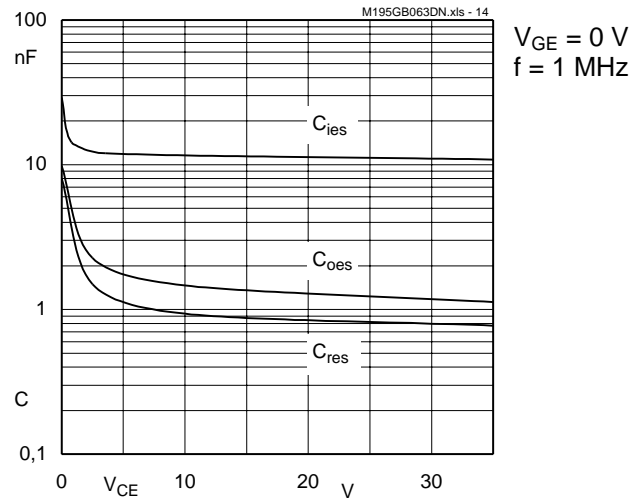

Fig. 14 Typ. capacitances vs. V_{CE}

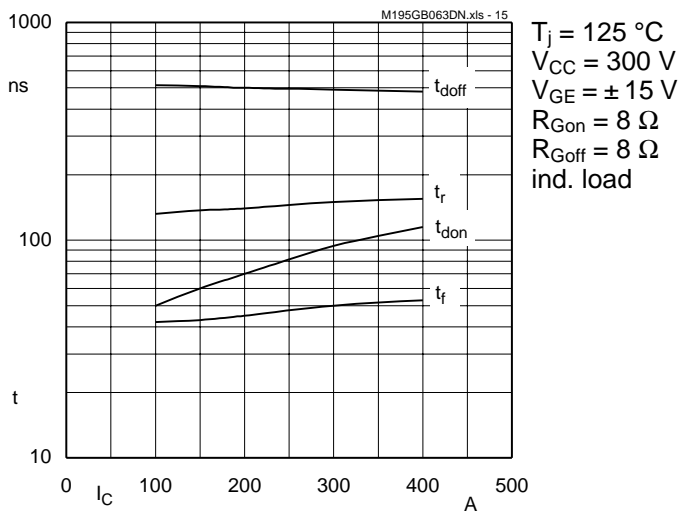

Fig. 15 Typ. switching times vs. I_C

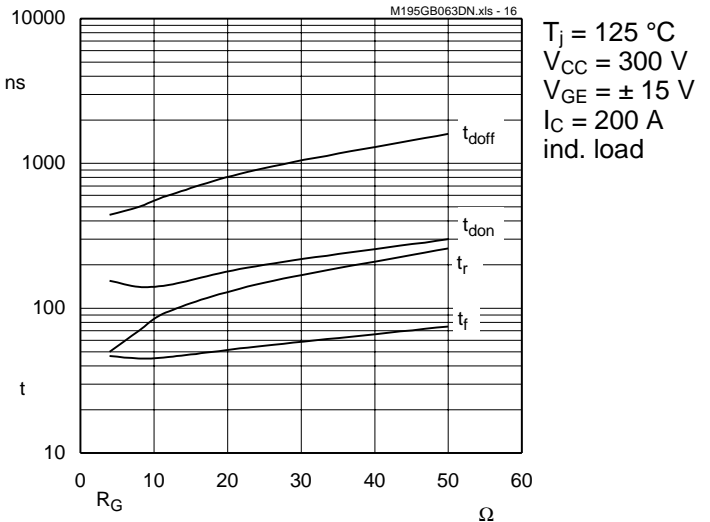

Fig. 16 Typ. switching times vs. gate resistor R_G

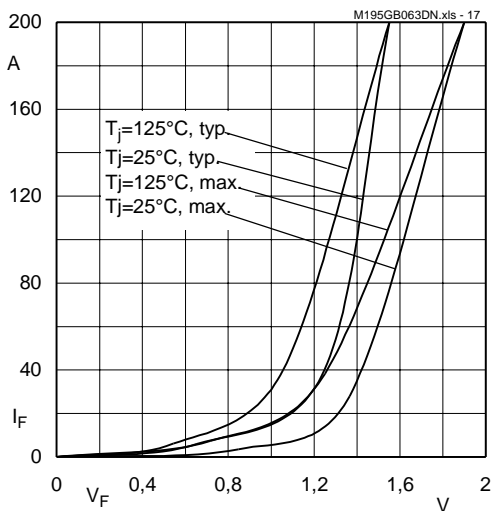

Fig. 17 Typ. CAL diode forward characteristic

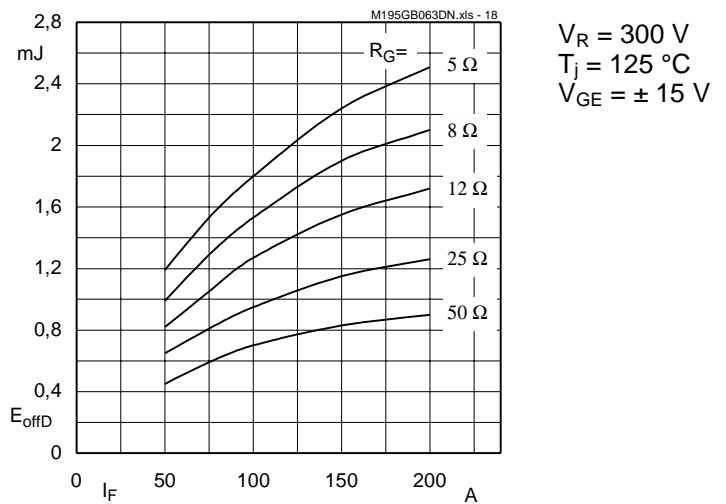

Fig. 18 Diode turn-off energy dissipation per pulse

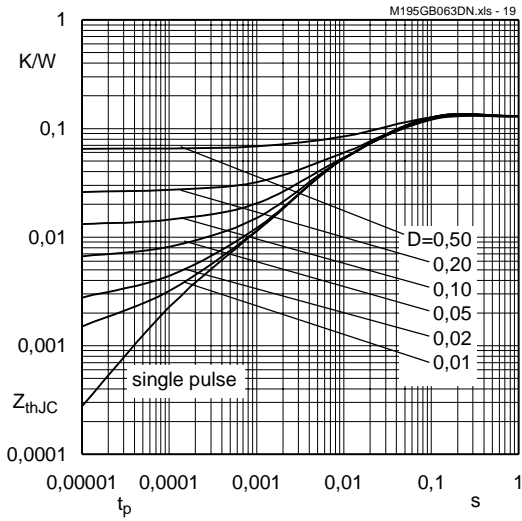

Fig. 19 Transient thermal impedance of IGBT
 $Z_{thJC} = f(t_p)$; $D = t_p / t_c = t_p \cdot f$

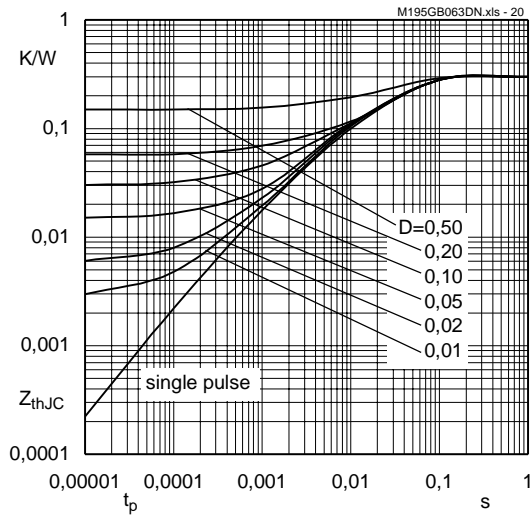

Fig. 20 Transient thermal impedance of inverse CAL diodes
 $Z_{thJC} = f(t_p)$; $D = t_p / t_c = t_p \cdot f$

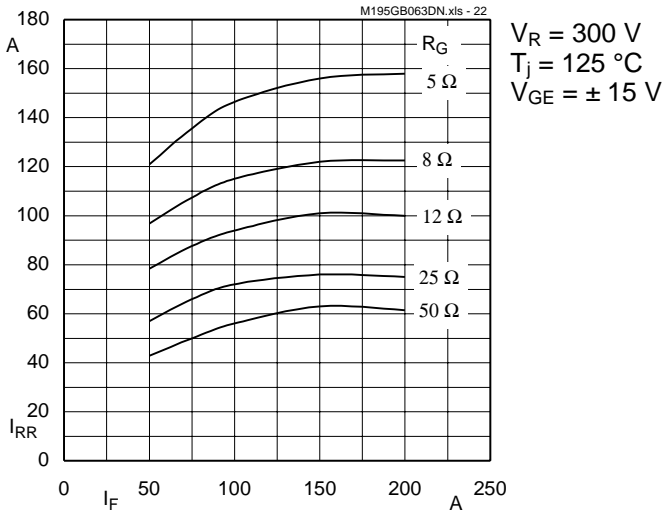

Fig. 22 Typ. CAL diode peak reverse recovery current $I_{RR} = f(I_F; R_G)$

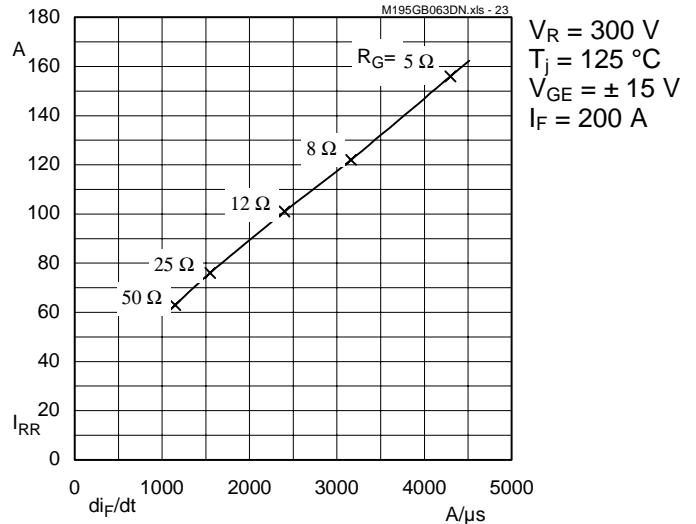

Fig. 23 Typ. CAL diode peak reverse recovery current $I_{RR} = f(di/dt)$

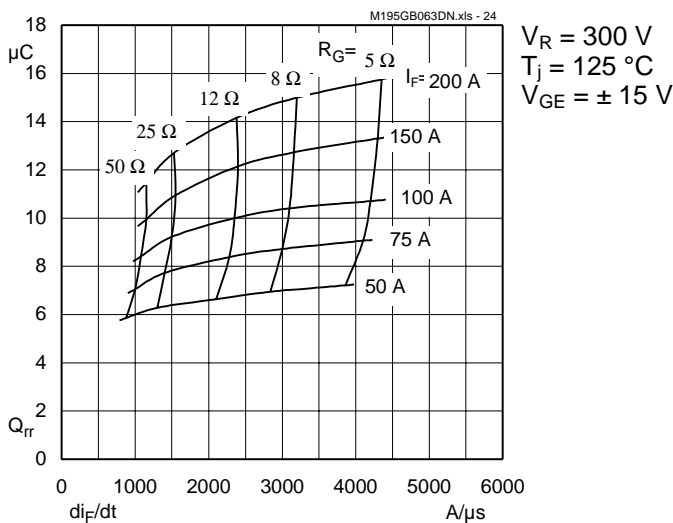

Fig. 24 Typ. CAL diode recovered charge

SEMITRANS 2N (low inductance)

Case D 93
 UL Recognized
 File no. E 63 532

CASED93

SKM 195 GB 063 DN

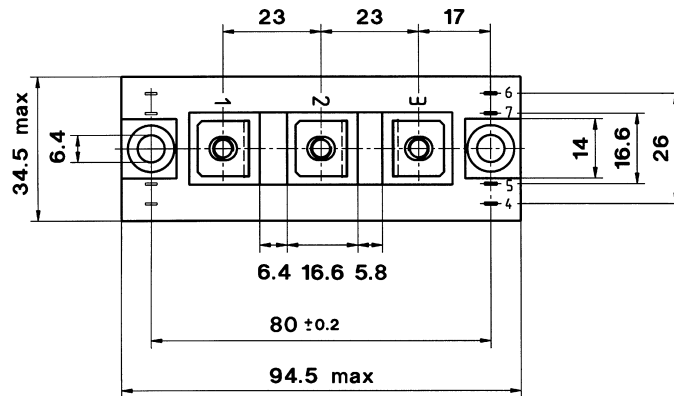
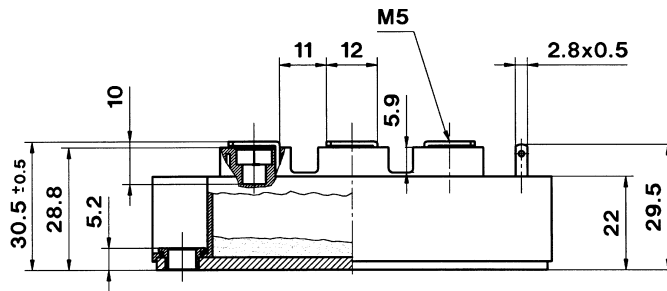
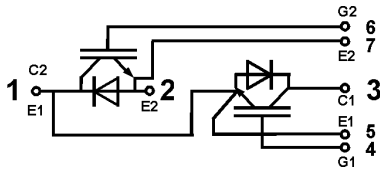

Dimensions in mm

SKM 195 GAL 063 DN

Case D 94 (→ D 93)

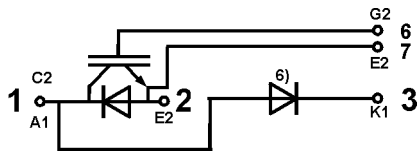

SKM 195 GAR 063 DN

Case D 95 (→ D 93)

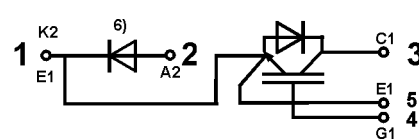

Case outline and circuit diagrams

Mechanical Data			Values			Units
Symbol	Conditions		min.	typ.	max.	
M ₁	to heatsink, SI Units to heatsink, US Units	(M6)	3 27	—	5 44	Nm lb.in.
M ₂	for terminals, SI Units for terminals, US Units	(M5)	2,5 22	—	5 44	Nm lb.in.
a			—	—	5x9,81	m/s ²
w			—	—	160	g

This is an electrostatic discharge sensitive device (ESDS). Please observe the international standard IEC 747-1, Chapter IX.

Eight devices are supplied in one SEMIBOX A without mounting hardware, which can be ordered separately under Ident No. 33321100 (for 10 SEMITRANS 2)

Larger packing units of 20 pieces are used if suitable

This technical information specifies semiconductor devices but promises no characteristics. No warranty or guarantee expressed or implied is made regarding delivery, performance or suitability.