

TOSHIBA GTR MODULE SILICON N CHANNEL IGBT

MG75Q1BS11

HIGH POWER SWITCHING APPLICATIONS.
MOTOR CONTROL APPLICATIONS.

Unit in mm

- High Input Impedance
- High Speed : $t_f = 1.0 \mu s$ (Max.)
- Low Saturation Voltage: $V_{CE(sat)} = 2.7V$ (Max.)
- Enhancement-Mode
- The Electrodes are Isolated from Case.

EQUIVALENT CIRCUIT

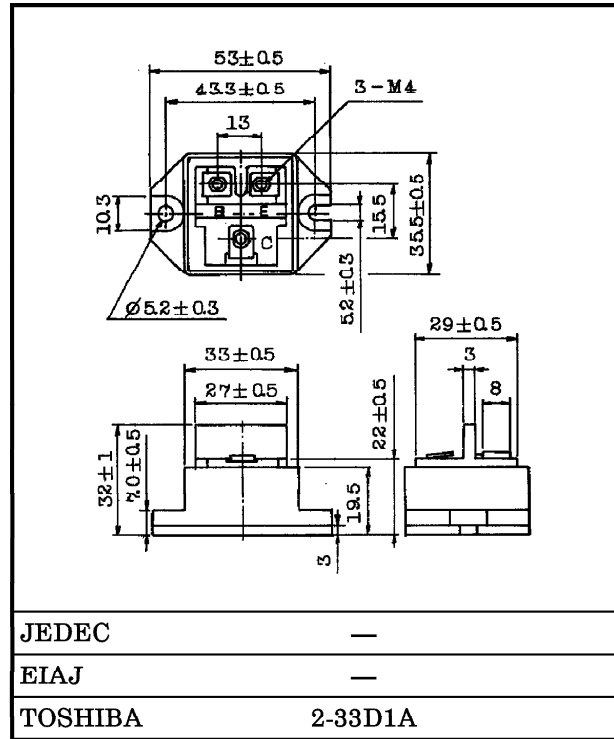
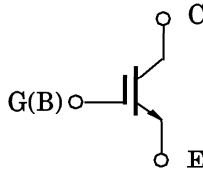

Weight : 90 g

MAXIMUM RATINGS (Ta = 25°C)

CHARACTERISTIC	SYMBOL	RATING	UNIT
Collector-Emitter Voltage	V_{CES}	1200	V
Gate-Emitter Voltage	V_{GES}	±20	V
Collector Current	DC	I_C	A
	1ms	I_{CP}	
Collector Power Dissipation (Tc = 25°C)	P_C	300	W
Junction Temperature	T_j	150	°C
Storage Temperature Range	T_{stg}	-40~125	°C
Isolation Voltage	V_{Isol}	2500 (AC 1 Minute)	V
Screw Torque (Terminal / Mounting)	—	2 / 3	N·m

961001EAA2

- TOSHIBA is continually working to improve the quality and the reliability of its products. Nevertheless, semiconductor devices in general can malfunction or fail due to their inherent electrical sensitivity and vulnerability to physical stress. It is the responsibility of the buyer, when utilizing TOSHIBA products, to observe standards of safety, and to avoid situations in which a malfunction or failure of a TOSHIBA product could cause loss of human life, bodily injury or damage to property. In developing your designs, please ensure that TOSHIBA products are used within specified operating ranges as set forth in the most recent products specifications. Also, please keep in mind the precautions and conditions set forth in the TOSHIBA Semiconductor Reliability Handbook.
- The information contained herein is presented only as a guide for the applications of our products. No responsibility is assumed by TOSHIBA CORPORATION for any infringements of intellectual property or other rights of the third parties which may result from its use. No license is granted by implication or otherwise under any intellectual property or other rights of TOSHIBA CORPORATION or others.
- The information contained herein is subject to change without notice.

ELECTRICAL CHARACTERISTICS (Ta = 25°C)

CHARACTERISTIC		SYMBOL	TEST CONDITION	MIN.	TYP.	MAX.	UNIT
Gate Leakage Current		I_{GES}	$V_{GE} = \pm 20V, V_{CE} = 0$	—	—	± 500	nA
Collector Cut-off Current		I_{CES}	$V_{CE} = 1200V, V_{GE} = 0$	—	—	1.0	mA
Collector-Emitter Voltage		V_{CES}	$I_C \leq 1mA, V_{GE} = 0$ Note 1	1200	—	—	V
Gate-Emitter Cut-off Voltage		$V_{GE} (OFF)$	$I_C = 75mA, V_{CE} = 5V$	3.0	—	6.0	V
Collector-Emitter Saturation Voltage		$V_{CE} (sat)$	$I_C = 75A, V_{GE} = 15V$	—	2.3	2.7	V
Input Capacitance		C_{ies}	$V_{CE} = 10V, V_{GE} = 0,$ $f = 1MHz$	—	10500	—	pF
Switching Time	Rise Time	t_r		—	0.3	0.6	μs
	Turn-on Time	t_{on}		—	0.4	0.8	
	Fall Time	t_f		—	0.6	1.0	
	Turn-off Time	t_{off}		—	1.2	1.6	
Thermal Resistance		$R_{th} (j-c)$	—	—	0.41	°C/W	

Note 1: Do not apply the over rating voltage.

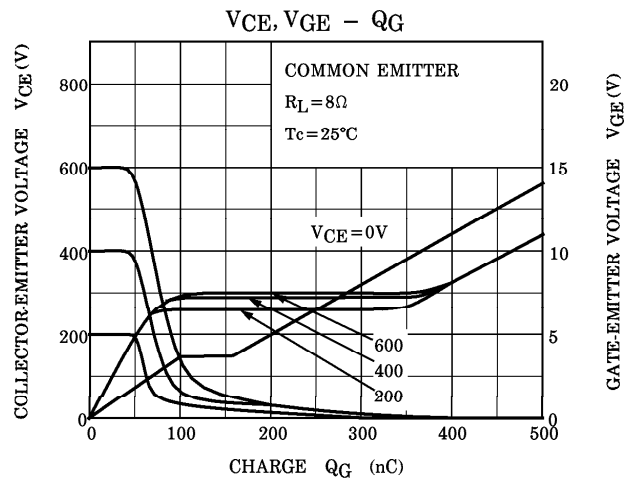
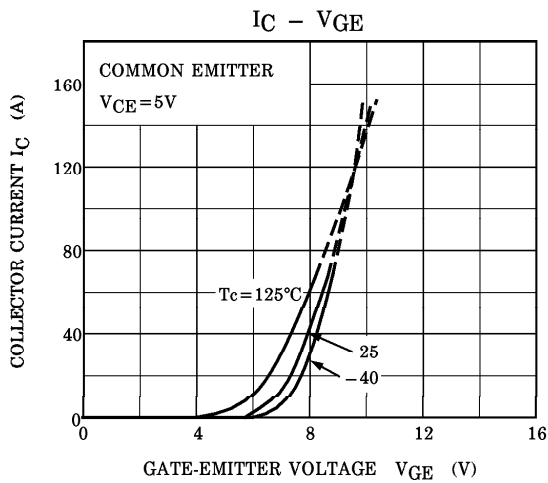
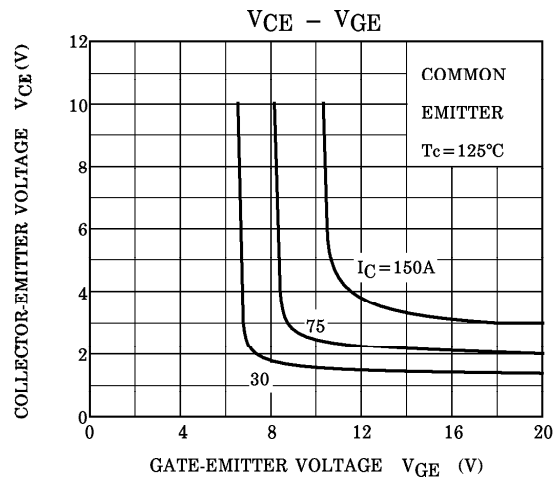
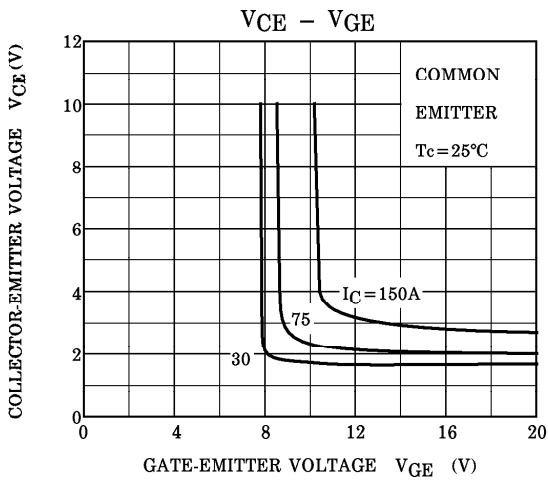
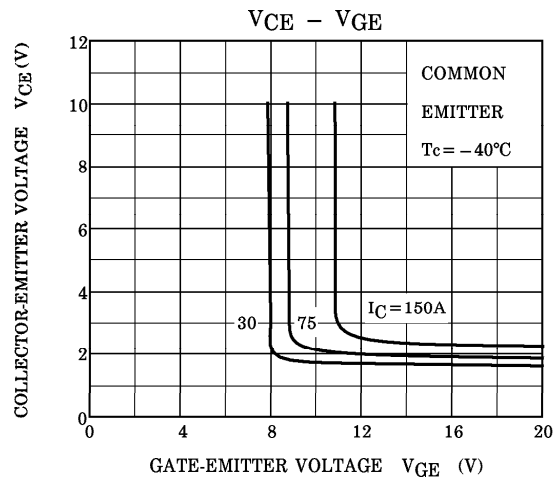
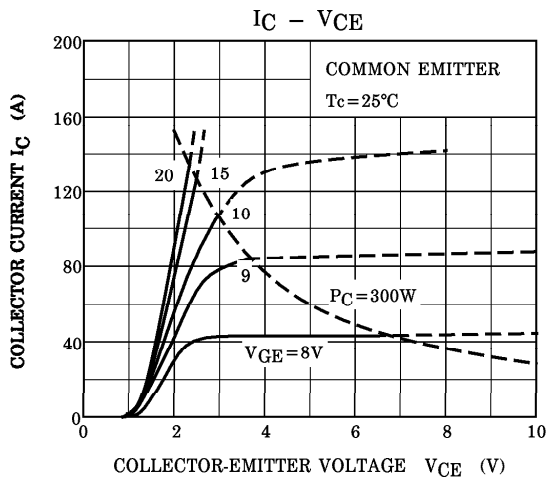

SWITCHING TIME - I_C

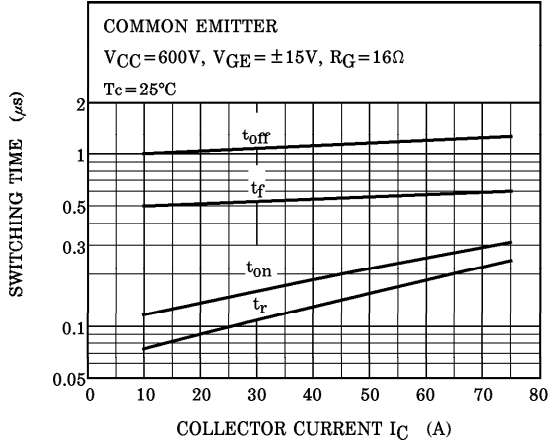

SWITCHING TIME - R_G

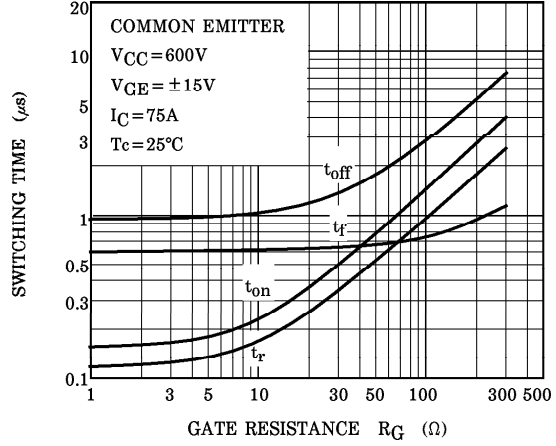

C - V_{CE}

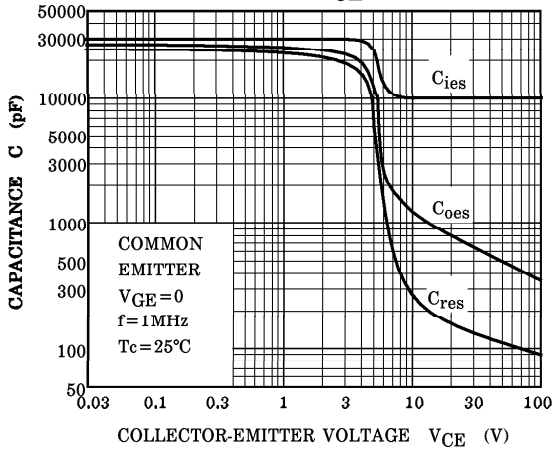

$R_{th}(t) - t_w$

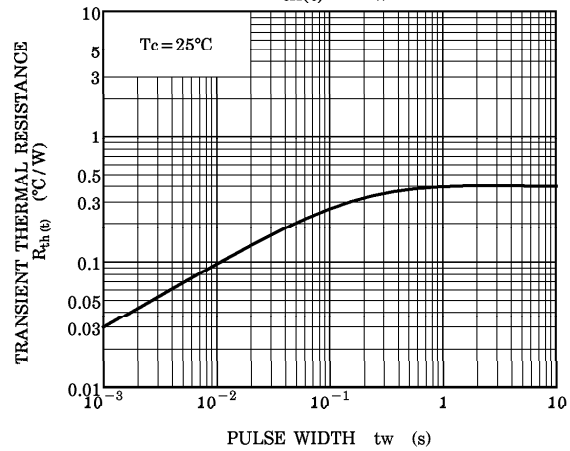

SAFE OPERATING AREA

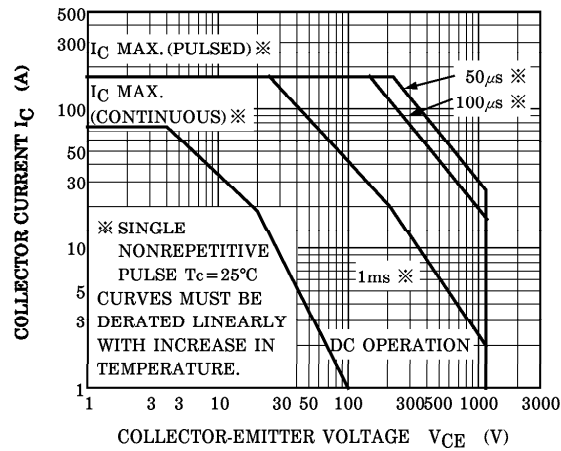

REVERSE BIAS SOA

