

Power Supplies Selection Guide

Product Overview/Quick Guide/Cat. No. Explanation



Bulletin 1606 — Power Supplies ① ②

Physical

- Quick mounting and connecting, innovative DIN-Rail mount, smallest in class

Electrical

- Low inrush current
- PFC choke
- Wide range input; auto select input
- Superior overload design (continuous current, no hiccup)
- NEC Class 2 'Limited Power' option
- Selectable operating mode (single/parallel)
- Superior efficiency and temperature rating

Special Modules

- Brownout buffer, DC to DC converter, N+1 redundancy

Approvals

- World-wide approvals ③
- NEC Class 2
- FM Class 1 Div. 2 (T3A)

① Not all features apply to all power supplies; see individual supply descriptions for specifics

② A more detailed list of performance specifications can be found at www.ab.com/industrialcontrols/products/power_supplies/index.html

③ Dual UL rating with cUL_{us} 60950 relating to approved use in information technology

Table of Contents

Quick Guide 4
 Cat. No. Explanation 4
 Product Selection 5
 Specifications 6
 Special Modules 10
 Approximate Dimensions 11
 Accessories 12
 1606-XL Redundancy Capabilities 13
 1606-XLBuffer 14

Standards Compliance



Bulletin 1606-(number from table) ④ Power Supply Quick Guide

	30...40 W	50 W	60 W	72 W	100 W	120 W	240 W	480 W	720 W	960 W
5...5.5V	XLP25A	—	—	—	—	—	—	—	—	—
10...12V	XLP30B	—	—	—	—	—	—	—	—	—
12...15V	—	XLP50B	—	—	—	—	—	—	—	—
(+/-)12 and 15V	XLP36C	—	—	—	—	—	—	—	—	—
24...28V 1-Ph	XLP30E	XLP50E	XL60D	XLP72E	XLP100E	XL120D	XL240E XL240EP	XL480E XL480EP XL480EPT	—	—
24...28V 3-Ph	—	—	—	—	—	XL120E-3	XL240E-3	XL480E-3 XL480E-3W XL480F-3H	XL720E-3	XL960E-3 XL960E-3S
36...43V	—	—	—	—	—	—	—	XL480GP	—	—
48...56V	—	XLP50F	—	—	XLP100F	—	XL240FP	XL480F	—	—
24V Redundant	—	—	XL60DR	—	—	XL120DR	XL240DR	XLRED20-30		XLRED40
	—	—	—	—	XLDNET4	—	XLDNET8	—	—	—

④ Example: For a 24...28 Volt, 3-Phase, 120 Watt power supply, the cat. no. would be 1606-XL120E-3.

Power Supply Cat. No. Explanation

Important: The following cat. no. breakdown is for explanation purposes only. It is not a product configurator. Not all combinations of fields are valid product cat. nos. First, select the desired power supply using the product selection table on page 5. Then, use this breakdown for verification and explanation only.

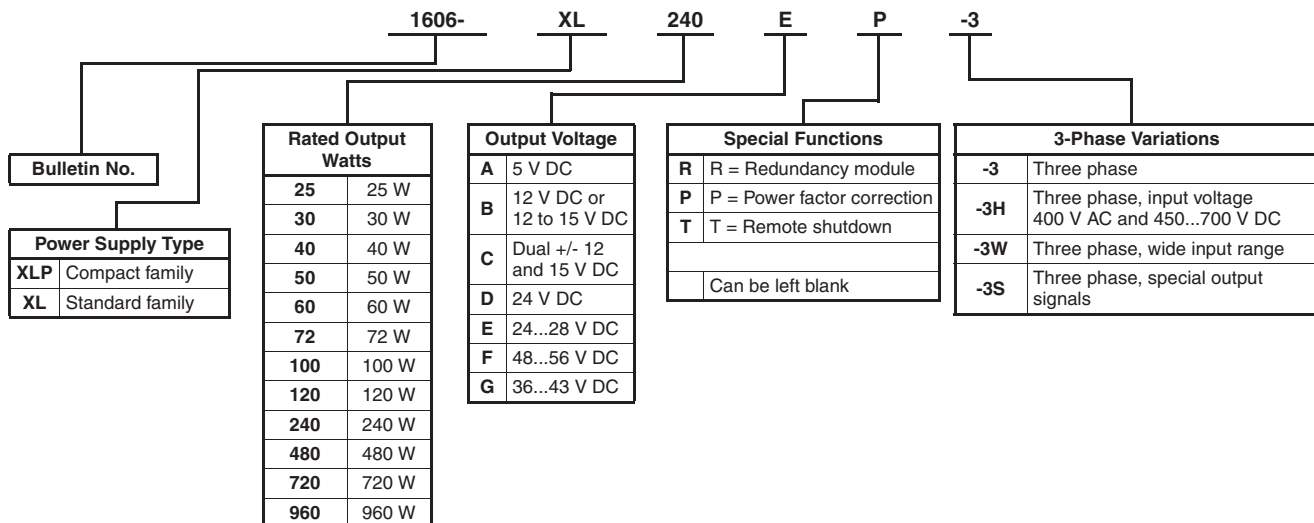

Bulletin 1606 Product Selection Table





	Output Power	Output Voltage	Special Feature(s)	Stocked Item	Parallel Operation (Inclined Characteristic)	Meets EN 61000-3-2 (PFC Harmonics)	Catalog Number
1606-XLP Compact							
Single Phase	25 W	DC 5...5.5V	NEC Class 2	X	—	N/A	1606-XLP25A
	30 W	DC 10...12V	NEC Class 2	X	—	N/A	1606-XLP30B
		DC 24...28V	NEC Class 2	X	—	N/A	1606-XLP30E
	36 W	DC +/- 12/15V	Output voltage adjustable	X	—	N/A	1606-XLP36C
		DC 12...15V	NEC Class 2	X	—	N/A	1606-XLP50B
	50 W	DC 24...28V	NEC Class 2	X	—	N/A	1606-XLP50E
		DC 48...56V	NEC Class 2	X	—	N/A	1606-XLP50F
	72 W	DC 24...28V	NEC Class 2	X	—	N/A	1606-XLP72E
	100 W	DC 24...28V	NEC Class 2	X	X Ⓣ	Yes	1606-XLP100E
DC 48...56V		NEC Class 2	X	X Ⓣ	Yes	1606-XLP100F	
1606-XL Standard Single Phase							
Single Phase	60 W	DC 24V	NEC Class 2	X	—	N/A	1606-XL60D
	120 W		—	X	—	Yes	1606-XL120D
	240 W	DC 24...28V	FM Class 1 Div. 2 T3A	X	—	No	1606-XL240E
			—	X	—	Yes	1606-XL240EP
		DC 48...56V	—	X	—	Yes	1606-XL240FP
	480 W	DC 24...28V	Low inrush current	X	X Ⓣ	No	1606-XL480E
			—	X	X Ⓣ	Yes	1606-XL480EP
		Remote shut down	X	X Ⓣ	Yes	1606-XL480EPT	
		DC 36...43V	—	X	X Ⓣ	Yes	1606-XL480GP
DC 48...56V	—	X	X Ⓣ	No	1606-XL480F		
1606-XL Standard Three Phase							
Three Phase	120 W	DC 24...28V	—	X	—	Yes	1606-XL120E-3
	240 W		Overload behavior selectable (FUSE Mode/continuous current), 2-phase operation admissible	X	X Ⓣ	Yes	1606-XL240E-3
			—	X	X Ⓣ	Yes	1606-XL480E-3
	480 W	Wide input range; overload behavior selectable (FUSE Mode/continuous current)	X	X Ⓣ	Yes	1606-XL480E-3W	
		DC 48...56V	Input voltage 400 V AC	X	X Ⓣ	Yes	1606-XL480F-3H
	720 W	DC 24...28V	—	X	X Ⓣ	Yes	1606-XL720E-3
	960 W		Passive load sharing	X	X Ⓣ	Yes	1606-XL960E-3
			Low inrush current; output signals	X	Active current sharing	Yes	1606-XL960E-3S
1606-XL Special Modules							
Special Modules	480 W	DC 23...27.8V	Brownout buffer module	X	—	N/A	1606-XLBUFFER
	40 W	DC 5.1V	DC/DC converter	X	—	No	1606-XLDC40A
	120 W	DC 24V	Electronically limited 4 A	X	—	Yes	1606-XLDNET4
	240 W	DC 24V	Electronically limited 8 A	X	—	No	1606-XLDNET8
	60 W	DC 24...28V	N+1 Redundant capable Ⓚ, NEC Class 2	X	X Ⓣ	N/A	1606-XL60DR
	120 W		N+1 Redundant capable Ⓚ	X	X Ⓣ	Yes	1606-XL120DR
	240 W		N+1 Redundant capable Ⓚ	X	X Ⓣ	No	1606-XL240DR
	720 W		V _{in} -5V typ.	Dual N+1 redundancy Ⓛ	X		N/A
	960 W	V _{in} -6V typ.	Single N+1 redundancy Ⓛ	X		N/A	1606-XLRED40





Accessories

1606 Accessory							
Accessory	—	—		X	—	—	
			Back of panel bracket for XL	X	—	—	1606-XLA

- Ⓚ Used with a pair of identical power supplies to offer N+1 redundancy
- Ⓛ To be used alongside 20 and 30 A power supplies (or smaller)
- Ⓣ Single/parallel operation (inclined characteristic) selectable (jumper); low inrush current
- Ⓛ To be used alongside 40 A power supplies (or smaller)

1606-XL Single Phase Specifications

					
Watts	24V/60 W	24...28V/120 W	24...28V/240 W	24...28V/240 W	48...56V/240 W
Input Voltage ②	AC 100...120/ 200...240V, Manual select, DC 160...375V	AC 100...120/ 200...240V, Manual select, DC 210...375V	AC 100...120/200...240V, Manual select, DC 240...375V		
Operational Range	85...132/176...264 V AC				
Hold-up Time	>20 ms (AC 196V)	>37 ms (AC 196V)	>25 ms (AC 196V)	>20 ms (AC 196V)	>25 ms (AC 196V)
Rated Input Current	<1.3 A/<0.7 A	<2.6 A/<1.4 A	<6 A/<2.8 A		
Efficiency	typ. 87.5%	typ. 90%	typ. 90%	typ. 89%	typ. >90%
Output Voltage	24V	24V	24...28V 24.5V preset	24...28V 24.5V preset	48...56V 48.5V preset
Rated Output Current	2.5 A	5 A	10 A (at 24V), 8.6 A (at 28V)	10 A (at 24V), 8.6 A (at 28V)	5 A (at 48V), 4.3 A (at 56V)
Power Boost		6 A	12 A	12 A	
Ripple/Noise (20 MHz)	<25 mV _{pp}	<50 mV _{pp}	<30 mV _{pp}	<30 mV _{pp}	<50 mV _{pp}
Operating Temperature range (T_{amb})	-10...+70°C >60°C with derating		0...+70°C >60°C with derating		
MTBF ③	740 000 hours	520 000 hours	425 000 hours	225 000 hours	425 000 hours
Dimensions (W x H x D)	49 x 124 x 102 mm	64 x 124 x 102 mm	120 x 124 x 102 mm		
Weight	460 g	620 g	980 g	1195 g	980 g
Approvals/Standards ④	1, 2, 3, 5, 6, 7		1, 2, 3, 5, 6	1, 2, 3, 5, 6, 7	
Special Features			⑤	PFC choke, ⑥	

					
Watts	24...28V/480 W				
Input Voltage ②	AC 200...240V DC 270...370V	AC 100...120/200...240V Auto select			
Operational Range	184...264 V AC	85...132/184...264 V AC			
Hold-up Time	30 ms (AC 230V)			>27 ms (AC 230V)	30 ms (AC 230V)
Rated Input Current	5 A	10 A/5 A			
Efficiency	typ. 91%	typ. 90%	typ. 90.5%	typ. 92%	typ. 93%
Output Voltage	24...28V Front panel potentiometer			36...43V/480W front panel potentiometer	48...56V Front panel potentiometer
Rated Output Current	20 A (at 24V), 18 A (at 28V)			13.0 A (at 36V), 11.2 A (at 43V)	10 A (at 48V), 8.6 A (at 56V)
Power Boost	25 A (22 A)			16.6 A (14 A)	12.5 A (10.7 A)
Ripple/Noise (20 MHz)	<20 mV _{pp} (single operation) <40 mV _{pp} (parallel operation)			<30 mV _{pp} (single operation) <80 mV _{pp} (parallel operation)	<40 mV _{pp} (single operation) <80 mV _{pp} (parallel operation)
Operating Temperature range (T_{amb})	0...+70°C >60°C with derating				
MTBF ③	519 000 hours				
Dimensions (W x H x D)	220 x 124 x 102 mm				
Weight	1800 g	2500 g			1800 g
Approvals/Standards ④	1, 2, 3, 5, 6	1, 2, 3, 5, 6, 7			1, 2, 3, 5, 6
Special Features	Single/parallel operation (inclined characteristic) selectable (jumper), ⑤	PFC choke, Overload behavior selectable (hiccup/continuous current), ⑥	PFC choke, ⑥	Single/parallel operation (inclined characteristic) selectable (jumper), PFC choke, ⑥	⑤

① 1) = CE, 2) = UL508 (cULus LISTED), 3) = UL1950 (cURus), 5) Safety standards = IEC/EN 60950, EN 50178, 6) EMC standards = EN 55011 (Class B), EN 55022 (Class B), EN 61000-6-2, 7) = EMC standards = EN 61000-3-2 (A14), EN 50081-1
 ② 47...63Hz
 ③ Low inrush current
 ④ FM Class 1 Div. 2, Groups A, B, C, D T3A
 ⑤ MTBF determined by Siemens norm SN 29500 at full load current and 40°C

Approximate Dimensions and Wire Size

Approximate dimensions are shown in inches (mm) unless otherwise indicated. Dimensions are not to be used for manufacturing purposes.

Bulletin 1606 Dimensions Table

Catalog Number	W	H	D ❶	Wire Size ❷	
				(Input and Output unless otherwise noted)	
1606-XLP25A	1.77" (45 mm)	2.95" (75 mm)	3.58" (91 mm)	Input/Output ❷ Stranded 28...12 AWG (0.3...2.5 mm ²) Solid 28...12 AWG (0.3...4 mm ²)	
1606-XLP30B					
1606-XLP30E					
1606-XLP36C					
1606-XLP50B					
1606-XLP50E					
1606-XLP50F					
1606-XLP72E					
1606-XLP100E	2.87" (73 mm)	2.95" (75 mm)	4.06" (103 mm)		
1606-XLP100F					
1606-XL60D	1.93" (49 mm)	4.88" (124 mm)	4.02" (102 mm)	Input/Output ❷ Stranded 20...10 AWG (0.5...4 mm ²) Solid 20...10 AWG (0.5...6 mm ²)	
1606-XL120D	2.56" (64 mm)	4.88" (124 mm)	4.02" (102 mm)		
1606-XL240E	4.72" (120 mm)	4.88" (124 mm)	4.02" (102 mm)		
1606-XL240EP					
1606-XL240FP					
1606-XL480E					
1606-XL480EP	8.6" (220 mm)	4.88" (124 mm)	4.02" (102 mm)		
1606-XL480EPT					
1606-XL480GP					
1606-XL480F					
1606-XL120E-3	2.87" (73 mm)	4.88" (124 mm)	4.61" (117 mm)		Input/Output ❷ Stranded 20...10 AWG (0.5...4 mm ²) Solid 20...10 AWG (0.5...6 mm ²)
1606-XL240E-3	3.50" (89 mm)	4.88" (124 mm)	4.61" (117 mm)		
1606-XL480E-3	8.66" (220 mm)	4.88" (124 mm)	4.02" (102 mm)		
1606-XL480E-3W	5.91" (150 mm)	4.88" (124 mm)	4.76" (121 mm)		
1606-XL480F-3H	8.66" (220 mm)	4.88" (124 mm)	4.02" (102 mm)		
1606-XL720E-3	9.45" (240 mm)	4.88" (124 mm)	4.41" (112 mm)		
1606-XL960E-3	10.83" (275 mm)	4.88" (124 mm)	4.61" (117 mm)	Input ❷ Stranded 20...10 AWG (0.5...4 mm ²) Solid 20...10 AWG (0.5...6 mm ²)	
1606-XL960E-3S				Output ❷ Stranded 22...8 AWG (0.5...10 mm ²) Solid 22...8 AWG (0.5...16 mm ²)	
1606-XLBUFFER	2.56" (64 mm)	4.88" (124 mm)	4.02" (102 mm)	Input/Output ❷ Stranded 20...10 AWG (0.5...4 mm ²) Solid 20...10 AWG (0.5...6 mm ²)	
1606-XLDC40A	1.93" (49 mm)	4.88" (124 mm)	4.02" (102 mm)		
1606-XLDNET4	2.56" (64 mm)	4.88" (124 mm)	4.02" (102 mm)		
1606-XLDNET8	4.72" (120 mm)	4.88" (124 mm)	4.02" (102 mm)	Input/Output ❷ Stranded 22...10 AWG (0.2...2.5 mm ²) Solid 22...10 AWG (0.2...2.5 mm ²)	
1606-XL60DR	1.93" (49 mm)	4.88" (124 mm)	4.02" (102 mm)	Input/Output ❷ Stranded 22...12 AWG (0.2...2.5 mm ²) Solid 22...12 AWG (0.2...2.5 mm ²)	
1606-XL120DR	2.56" (64 mm)	4.88" (124 mm)	4.02" (102 mm)		
1606-XL240DR	4.72" (120 mm)	4.88" (124 mm)	4.02" (102 mm)		
1606-XLRED20-30	1.89" (48 mm)	4.88" (124 mm)	4.02" (102 mm)	Input/Output ❷ Stranded 20...10 AWG (0.5...4 mm ²) Solid 20...10 AWG (0.5...6 mm ²)	
1606-XLRED40	1.89" (48 mm)	4.88" (124 mm)	4.61" (117 mm)		



❶ Depth measurement does not include DIN rail.
 ❷ The wire sizes indicated refer only to the connection capability of the terminal.
 For proper operation, the correct wire size must be used (based on accurate determination of the electrical characteristics and loading of the system).